

U-TECK™

Your Safety... Our Solutions.

www.uteck.com | 1-800-542-7011

159 Rock Hill Rd, Fayetteville NC 28312

PRODUCT CATALOG

Revolutionize Your Fiber Optic Workflow!

Because your hands should be on the splicer, not chasing cable.

FIBER DROP CADDY

Rewinder Feature using portable drill!



VPN: 55803

POLE BRACKET

Securely attach your LSP to utility poles with our LSP Pole Bracket!



VPN: 59410

HI-ROLLER TRIPOD



LED ADJUSTABLE WORK LIGHT

Can be attached to the Worksurface for Nighttime Conditions.

VPN: 55802



SAFE-T LID

Temporary Covers provide fall-in protection

VPN: 28024-Y



TETHER ACCESSORY

Store your splicer seat to your Fiber Workstation for easy storage and mobility.

VPN: 55745



Thank you for Choosing **U-TECK!**

U-TECK™
Your Safety... Our Solutions.
CABLE PULLING AND
PLACEMENT



U-TECK's mission is to provide our customers with exceptional value through personalized solutions, service, and innovative products, and to continually look for ways to improve our quality management system.

U-TECK™
Your Safety... Our Solutions.

NOTES

Q
E
E
Q
E

TABLE OF CONTENTS

Splicing Solutions

Fiber Optic Splicing Workstation	1
Workstation Accessories	2
Fiber Grip Splicing Clamp	3
Splice Case Stand	4
Portable Splicing Rig	5
Ladder Splicing Platform	6
Ladder Splicing Platform Accessories	7
Splicer Seat	8
Splicer Seat Accessories	9
Bucket Splicing Platform	10
Bucket Splicing Platform Accessories	11
Work Center Ergo Seat	12
Fiber Optic Protection Sleeve	13

Cable Pulling & Placement

RayDius Fiber Quadrant Block	14
Quadrant Block Support Bar	15
Super Jamb Jamb Skid	16
Super Jamb Jamb Skid Features	17
Cable Pulling Mesh Grips	18
Mesh Grip Bulk Reel	19
Radius Bend Tool	20
Cable Reel Pole Bracket	21
Fiber Drop Caddy	22
Fiber Drop Caddy Instructions	23
Fiber Coil Turn Table	24
Fiber Coil Turn Table Instructions	25
Reel-Deal Cable Caddy	26
Reel-Deal Single Line Pull Caddy	27
Hi-Roller and Accessories	28
Hi-Roller Instructions	29

Mounting Equipment

Fire-Retardant Interior Backboards	30
Exterior Backboards	31
Backboard Specifications	32
Backboard Ordering Information	33

Tents

Manhole Tent / FTTH	34
Vent Tent	35
Cold Weather Tent	36
Canopy Tent	37
Canopy Tent Accessories	38

Weed Control

Utility Pole Mat Kit	39
Ped-Mat	40
Ped-Mat Specs	41

Cable Protection

Street Saver/ Street Saver SLIM	42
Micro-Trenching Tamper Tool	43
TempCable Protector	44
Cable & Wire Storage Box	45

Ladder Safety

Rung Runner Ladder Caddy	46
Step Runner Ladder Caddy	47
Universal Ladder Wedge	48
Pole Mounted Ladder Bracket	49
Pole Mounted Ladder Bracket Assembly Instructions	50

Specialty Tools

Temp Fiber Drop Markers	51
Handhole Cover Removal Tool	52
Magic Wrap	53

Ventilators

Ventilators	54
Ventilator Accessories	55

Heaters

Bucket Heater	56
Big Buddy Heater	57

Umbrellas

Dialectic Umbrellas	58
Work Umbrellas	59

Underground Solutions

Buried Closures	60
Buried Closures Dimensions	61
Sealguard II Water Sealing Solutions	62

Worker Safety

Attic-Trax <i>Illuminated walk boards</i>	63
Attic-Trax <i>Information</i>	64
Attic-Trax <i>Instructions</i>	65
Wheel Chocks	66
Safe-T Lid & Versa Lid	67
Chain Hoists	68
Handi Hoists	69
Handi Hoists <i>Inatructions</i>	70

FIBER OPTIC SPLICING WORKSTATION

1

U-TECK is proud to offer the next generation fiber splicing workstation to support fiber splicing at the splice or optical network terminal (ONT).

The NEW! Fiber Optic Splicing Workstation has a larger work surface, but offers the ability to fit in most work sites. It can be used as a freestanding workbench or in narrow manhole environments, inside tents, central office work, and light enough for aerial work in a bucket or attached directly to the cable support strand by removing the work surface from the stand.

Features:

- Portable workbench
- Large work surface
- Compact fold-up
- Built in slots & holes for tools
- Heavy duty steel legs
- Quick-attach standoffs for hanging
- Adjustable height
- Cable management attachment included

The heavy duty, steel legs lock firmly to the work surface at heights of 32" and 40" tall, keeping your table at a comfortable working level. Our unique Cable Management Bracket fits securely on either side of the workbench, allowing jacketed strands to stay put and separated until you need them.

Separate the work surface from the stand and quickly attach the two unique stand-off props with adjustable webbing into the 4 accessory slots and you can take your work table to new heights, giving you a secure and level work surface when hanging it over terminal casings inside data rooms, closets, and outdoors against a wall for wall-mounted ONT's or NID's.



Ordering Information

Product:	Description:	VPN:
Workstation	with floor stand only	55700 55701
Workstation w/stand-offs	with floor stand + cable management bracket, and stand-offs	55706
Workstation w/bracket	with floor stand + cable management bracket	

Fiber Optic Splicing WorkStation Accessories

Attach the Aerial Strand Cables into the 4 accessory slots and your table is right where you need it for work at the cable support strand while working from an aerial bucket truck. The Workstation surface area is approximately 35-1/2" x 22-1/2", with an inside recessed area of 22" x 18" and a weight capacity of 100 lbs. Slots and holes are molded into the table to conveniently hold tools, parts, splicing sleeves and other splicing equipment. This recessed area prevents small pieces from rolling off. The table folds up neatly for quick and easy transport and storage. If you use the Workstation with the table top, floor stand and cable management bracket, it will weigh in at 17.63 lbs. Hanging the Workstation using just table top, stand-offs, and the cable management bracket, the total weight is a mere 10.27 lbs! No matter where your fiber splicing duties take you, you'll want to have this lightweight Workstation available at all times. Durable, portable and stable, this will become a standard in your splicing environment.

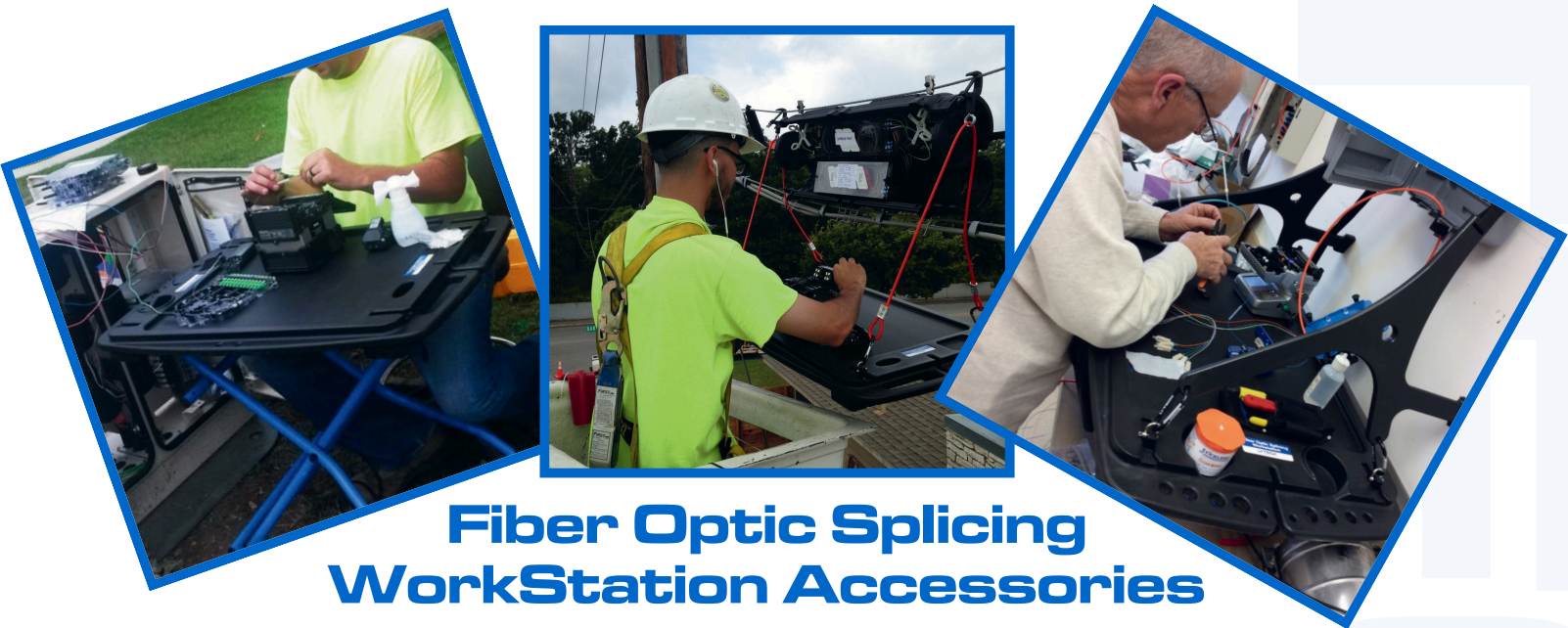

Fiber Optic Splicing WorkStation Accessories



FiberSplice
CaseStand
VPN: 55712 10 lbs

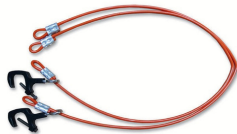

Aerial Strand Cables
VPN: 55715 1 lb



Stand-Offs
VPN: 55711 2.4 lbs



Tablet Holder
VPN: 55720 1.7 lbs



Splice Tray Holder
VPN: 55725 .51 lbs



Wheel Kit
VPN: 55740 10 oz



LED Dual Power Light with
Magnifying Glass
VPN: 55615 1.45 lbs



Leveling Kit
VPN: 55742



Fiber-Grip Splicing
Clamp
VPN: 55755



Splicer Seat Tether
VPN: 55745 5 oz



Black Poly-Mesh 3-
Pocket Pouch
VPN: 55710 .15 lb

FIBER-GRIP SPLICING CLAMP

U-TECK's FIBER-GRIP Splicing Clamp was designed specifically for our Fiber Splicing Workstation. The FIBER-GRIP will securely hold and manage loose fiber, ribbon, tubes, or cables up to .5" diameter while you are splicing. Quickly attaches to the Workstation at one of two locations simply with a toggle clamp.



Ordering Information

Product:	Description:	VPN:
Fiber Grip Splicing Clamp	1.6 Lbs	55755

www.uteck.com | 1-800-542-7011

FIBER SPLICE CASE STAND

The *Fiber Splice Case Stand* is a portable support stand designed to hold fiber closures when performing splicing duties. It is strong, lightweight, and able to fit your real-world splicing environments. Simple to use, it sets up quickly with your fiber case held securely to the stand platform with self gripping, velcro straps.

Features:

- Secures splice cases for fiber work
- Portable and lightweight construction
- Locking safety hinge pin platform and knob-style tension locking legs
- Can be used Horizontally or Vertically
- Works with most splice case sizes
- Load capacity 132 lbs.
- Maximum tripod height is 63" with a minimum of 40"
- Tripod is made of reinforced metal tubing and the legs feature knob-style tension locking.

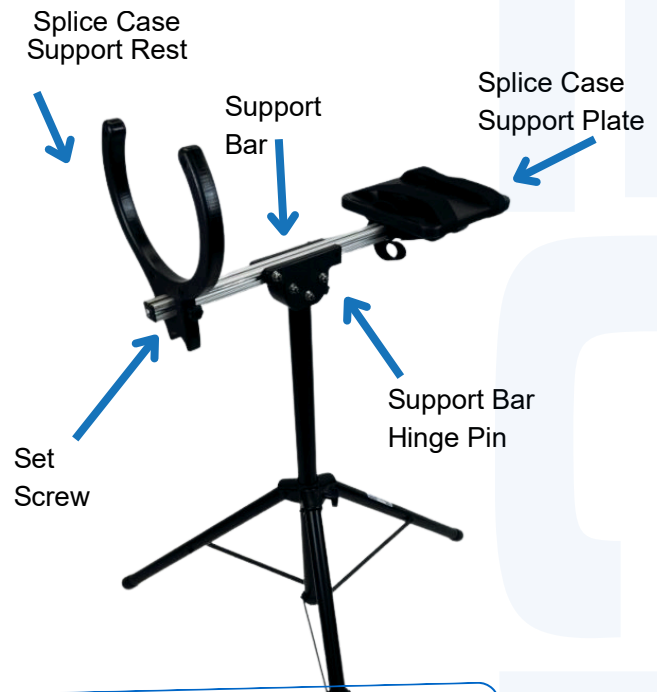
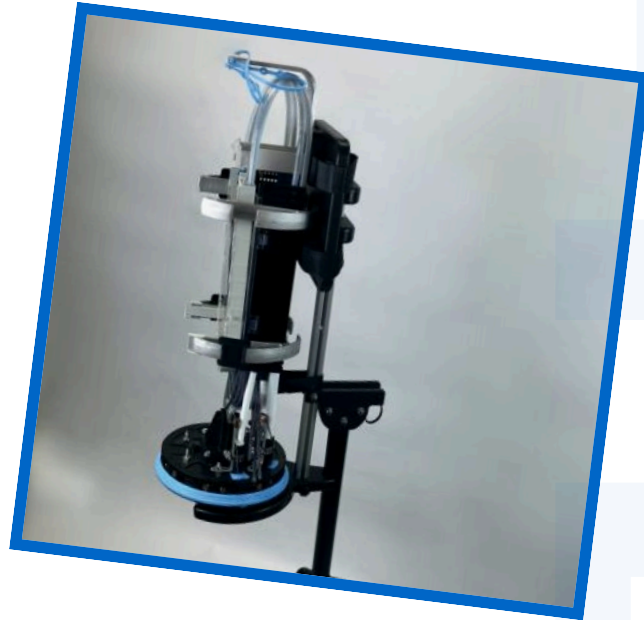

Ordering Information

Product :	Description:	VPN:
FIBER SPLICE CASE STAND	Tripod	55712

SPLICE FASTER! WORK SAFER! GO ANYWHERE!

PORTABLE SPLICING RIG

5

U-TECK Portable Wearable Splicing Rig – Splice Anywhere, Hands-Free!

Tired of struggling with your fusion splicer in tight spaces, manholes, attics, or during emergency repairs? The U-TECK Portable Splicing Rig lets you work smarter — mounting your splicing machine securely onto the harness so you can splice quickly and comfortably anywhere.

This innovative wearable rig transforms how fiber technicians work in the field. Simply slip on the lightweight harness over your shoulders, and you are splicing in seconds. No neck straps. No waist belts. Just a secure, fully adjustable shoulder harness that fits any body shape or size — comfortable whether you're standing, sitting, or working at a terminal.

Features:

- Hands-free mobility — Securely holds your fusion splicer on a stable, non-slip platform with a heavy-duty security knob for fast, safe attachment.
- All-day comfort — Padded shoulder frame distributes weight evenly. Weighs only 5 lbs. for reduced fatigue.
- Smart onboard storage — Built-in compartments and attachment points keep wipes, cleaners, splice sleeves, tools, and accessories right where you need them.
- Accessories available include — Flexible LED work light (shown) for low-light conditions, cleaver mount (shown), and 5" 3X magnifier.
- Ultra-portable design — Quickly breaks down for easy storage or hangs neatly on your truck's passenger seat for instant access for the next job.



Perfect for quick turn-ups, emergency restorations, bucket work, or any location where a traditional workstation won't fit. Built tough in the USA by U-TECK and engineered for real-world fiber optic technicians who demand speed, safety, and reliability.



Ordering Information

Product:	Description:	VPN:
Portable Splicing Rig	5.5 Lbs	57000
LED Adjustable Light with 9" Flexible Gooseneck	1 Lbs	55806-9
LED Adjustable Light with 18" Flexible Gooseneck	1 Lbs	55806-18
Cleaver Mount with 9" Flexible Gooseneck	1 Lbs	55807-9

www.uteck.com | 1-800-542-7011

LADDER SPLICING PLATFORM

U-TECK's new Ladder Splicing Platform solves the problem of Splicing while on a ladder!

Transporting and assembling a makeshift splicing platform while trying to maneuver up extension ladders was, in the past, a difficult and UNSAFE task. Our ALL NEW Splicing Platform attaches directly to the ladder for a secure, stable work area that measures 13.5"x9.5". The all NEW Splicing Platform is strong (but lightweight) and can be adjusted for splicing on either the left or the right side to accommodate dexterity as well as any interference that may occur on either side while splicing. The LSP is incredibly versatile- it works with EVERY ladder we have been able to find! Secure your splicing machine with the Captive Knob (included) and splice comfortably - at NIOSH recommended 75 - while working atop ladders! We've also included a slot to accept our 5-pocket tool pouch to keep an assortment of tools conveniently at hand.



Ordering Information

Product:	Description:	VPN:
Ladder Splicing Platform	8.5Lbs.	55800
Cleaver Mount	1Lbs.	55801
LED Adjustable Work Light Kit	2Lbs.	55802
Pole Bracket for LSP	7Lbs.	55803

All LSP Accessories are
easy on, easy off

ACCESSORIES 7

POLE BRACKET

Securely attach your LSP to utility poles with our LSP Pole Bracket!

- Fits wide range of pole diameters
- Converts from Left to Right for Splicing Ease
- Secures with 2 retractable Ratchet Straps

VPN: 55803



CLEAVER MOUNT

Cleaver securely attaches with one screw. And is adjustable to your preferred working angle.

VPN: 55801



RECHARGABLE LED LIGHT

- LED Light with Adjustable Arm
- 3100mAh built in Lithium Battery
- Lasts 150-minute at 100% brightness, over 15 hrs for 10% brightness!

VPN: 55802

INSTRUCTIONS FOR USE

**USB-C Charger Included*

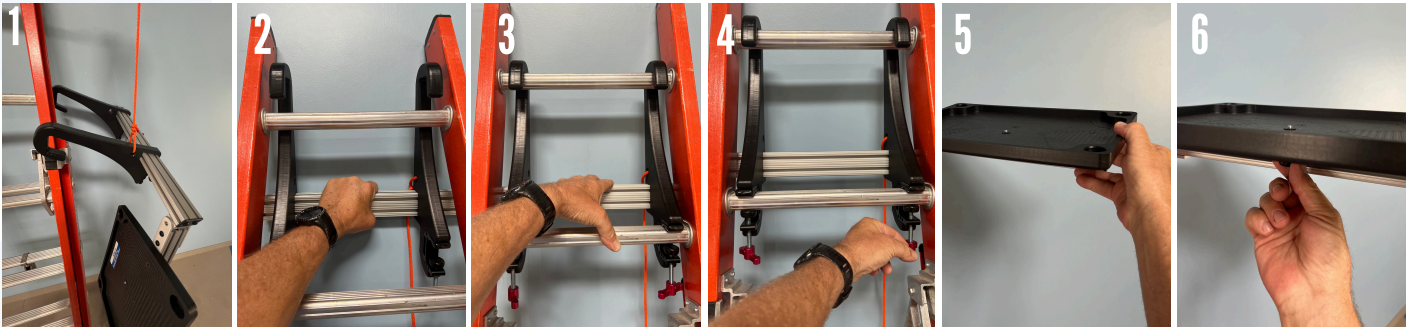

1 Attach handline to platform using pre-approved handlining procedures.

2 Once handlined up, hang device onto rung at desired location.

3 Once secure, pull base to secure on rung underneath.

4 Secure in place with Red adjusting clamps

5 Adjust platform to desired working position

6 Secure Splicing Machine to platform using captive knob provided.

Ordering Information

Product:	Description:	VPN:
Ladder Splicing Platform	8.5Lbs.	55800
Cleaver Mount	1Lbs.	55801
LED Adjustable Work Light Kit	2Lbs.	55802
Pole Bracket for LSP	7Lbs.	55803

www.uteck.com | 1-800-542-7011

SPLICER® SEAT

U-TECK has combined a longtime, craft-accepted design with a new polyethylene material to produce a rugged splicer seat that can be warranted for up to five years.

With the U-TECK Splicer Seat, there is never a need for water treatment because it is waterproof. No need for painting, either; the color is molded into the seat. And no worries about splintering. It is ouchless! This seat can be drilled to attach other equipment, such as splicing machines.

Features:

- Extremely rugged
- Convenient tool slot
- Traditional design
- Large sitting area
- Polyethylene material
- Textured surface
- Five-year warranty
- Available in grey & safety orange

U-TECK has even included a handy tool slot in the top to hold your tools, connectors, or other small items when you need them close at hand. Conventional splicing machines can be attached to the Splicer Seat. The unique design of the seat allows it to be used at three different positions for varied heights. The Splicer Seat also makes an excellent footstool. With this seat, you will never need to purchase a replacement again.



Ordering Information

Product:	Description:	VPN:
Grey "P" Splicer Seat	10 lbs., 18"L x 14.75"W x 11.75"H	55430
Orange "P" Splicer Seat	10 lbs., 18"L x 14.75"W x 11.75"H	55430-OR



MS2 Splicer Adapter

Fits on your MS2 Splicing tool to easily attach and remove it from the splicer seat



Seat Cushion

Thickly padded cushion in a weather-resistant cover. Comes complete with three large pockets for tools and materials.



Universal Splicing Head Adapter

Used to temporarily attach either a 710 or MS2 splicing machine to the Ergonomic Seat or the 'P' Splicer Seat. Can be mounted in several locations as desired by individual splicers.

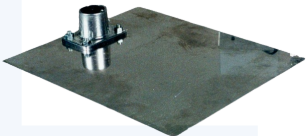

Splicing Arm Base

Fits under your Splicer Seat to attach your modular splicing tool when you do not want to attach it directly to the seat.



710 Splice Adapter

Fits on your 710 modular splicing tool to easily attach and remove it from the Splicer Seat



Tool Base Adapter



Assists you when permanently attaching your 710 splicing tool to the Splicer Seat

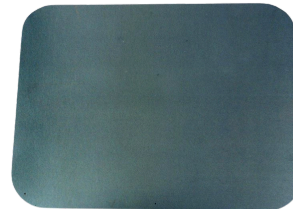

Splicing Mat

3ftx4 ft rugged, washable and reusable pad that covers the work area. Keep your cables out of the dirt and your tools out of the mud and weeds!



Retro Fit Kit

Allows the upgrade from the Splicer Seat to the Ergonomic Seat. Includes the splicer seat adapter, the Ergonomic Seat and even the drill bits to drill the holes.



Ordering Information

Product:	Description:	VPN:
MS2 Splice Adapter 710	1 lb.	55420
Splice Adapter Tool Base	1 lb.	55500
Adapter Seat Cushion	1 lb.	55450
Splicing Mat Splicing Arm	3 lbs.	55430-CU-BLK
Base Universal Splice	6 lbs.	55430-MAT 55430-BASE
Adapter Retro Fit Kit	16 lbs.	55460 55430-RETROKIT

Bucket Splicing Platform

U-TECK's Bucket Splicing Platform is Purpose Built and Well-Suited for Field Technicians who need a Reliable and Portable Worksurface for their Aerial Splicing and Maintenance Tasks.

This Convenient Platform is Designed to Enhance Efficiency and Safety, Making it an Ideal Choice for Technicians Working in Diverse Field Conditions.

Features:

- Universally Designed to Securely Fit Most Buckets, With or Without Liners, Composite or Steel Framed.
- Securely Attaches in Seconds.
- Lightweight at just over 12 pounds for Portability and Ease of Use.
- Large 12"x24" Non-Conductive Work Area.
- Organized Storage for Alcohol Dispenser, Cleaning Wipes, Splice Sleeves, etc.
- Foldable for Easy Storage when not in use.
- Captive Screw for Securing Splice Machine.
- Includes 2 Leveling Features for a Stable Worksurface.
- Equipped to Secure Various Types and Brands of Splice Cases.

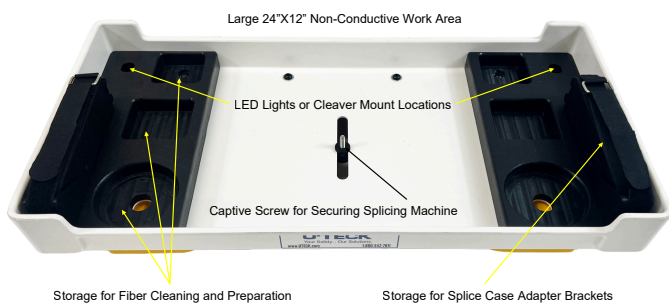

Ordering Information

PRODUCT:	Description:	VPN:
Bucket Splicing Platform	13 lbs., 25" x 13" x 6"	56000

Bucket Splicing Platform Accessories

11

U-TECK's bucket splicing platform accessories can also be easily attached.

The LED Adjustable Work Light and Cleaver Mount Can be attached to the Worksurface for Nighttime Conditions.

Cleaver Mount securely attaches with one screw and is adjustable to your preferred working angle.



LED adjustable work light Includes adjustable arm Lasts 150-minute at 100% brightness Lasts over 15 hours at 10% brightness.

Ordering Information

Product :	Description :	VPN:
LED Adjustable Work Light	Includes charging cord With Adjustable Arm	55802
Cleaver Mount	accessory for Bucket Splicing Platform and Ladder Splicing Platform	55801

www.uteck.com | 1-800-542-7011

WORKCENTER ERGO SEAT

U-TECK has taken a field-proven and craft-accepted design—the “P” Seat—and incorporated it into The WorkCenter, the newly designed Ergo Splicer Seat workstation. The upper portion of this seat removes easily, making setup possible even in tight, hard-to- maneuver spaces

Features:

- Anti-Skid Bottom
- Convenient Tool Slot
- Swivel 360 Degrees
- Seat Back and Cushion Area removeable & foldable
- Weather Resistant
- All Hardware is Stainless Steel
- Breaks down For Tight Places & Easy Storage
- Seat Can Be Used With or Without Back
- Base is available in Grey & High-Vis Safety Orange



The WorkCenter as a complete unit is available to be ordered, or you can purchase a simple kit which will retro fit the thousands of existing Splicer Seats that are being used by companies today. This will result in a tremendous savings for your individual budget. The multi-faceted unit is also the toolbox personnel are accustomed to, which lets them keep their tools and materials convenient during an entire operation. U-TECK has also designed a new Universal Splicing Head Adapter for mounting splicing heads to the seat base. This adapter will accept virtually any splicing machine. It may be mounted in different positions to accommodate the preference of the individual splicer.

Ordering Information

Product:	Description:	VPN:
"P" Seat with Ergo Seat	13/12 lbs., 18" x 12" x 15" and 16" x 15" x 24"	55430-SS
"P" Seat with Ergo Seat and Tool Pouch	13/12 lbs., 18" x 12" x 15" and 16" x 15" x 24"	55430-SS-POC
WorkCenter Retrofit Kit	16 lbs., 13/12 lbs., 18" x 12" x 15" and 16" x 15" x 24"	55430-RETROKIT
WorkCenter Retrofit Kit with Tool Pouch	16 lbs., 16" x 15" x 24"	55430-RETROPOC

FIBER OPTIC PROTECTOR SLEEVE

13

U-TECK's Fiber Optic Protector Sleeves were developed to protect and strengthen fusion splices on fiber cables. The construction of the three separate protective and strengthening elements of the sleeve are distinctive in the function that each provides.

The inner stainless steel pin keeps the sleeve rigid and stable. The pins are vibratory tumbled with a special medium. This eliminates the possibility of fiber scarring or material penetration, preventing damage to sensitive glass fibers.



The outer tube is manufactured of a heat shrinking polyolefin. This encloses the inner tube and the encapsulated fiber splice, providing double protection and ensuring that moisture and air are eliminated from the fiber splice. U-TECK's Fiber Optic Protector Sleeves are available in a standard length of 2 3/8" and are adaptable with all standard organizers. However, various lengths are available upon request.

Ordering Information

Product:	VPN:	Description:
Fiber Optic Protector Sleeve	55501	1.69 oz.

www.uteck.com | 1-800-542-7011

RayDius™ FIBER QUADRANT BLOCK

***Always refer to recommended guidelines from cable manufacturers.**

U-TECK's New RayDius™ Fiber Quadrant Block is designed to protect fiber optic cable during installation.

This product can be used as in Infeed Guide or an Outfeed Guide for Fiber Cable to prevent breakage, which can occur on some standard quadrant blocks. Pulling Diameter of 40" MBD (101cm), 600lbs (2700N) Max Cable Tension Load. Using a new, gently curving solid design we were able to provide a smooth contour, while maintaining the required bend radius of the Fiber Optic Cable, and eliminating breakage caused from contact pressure.

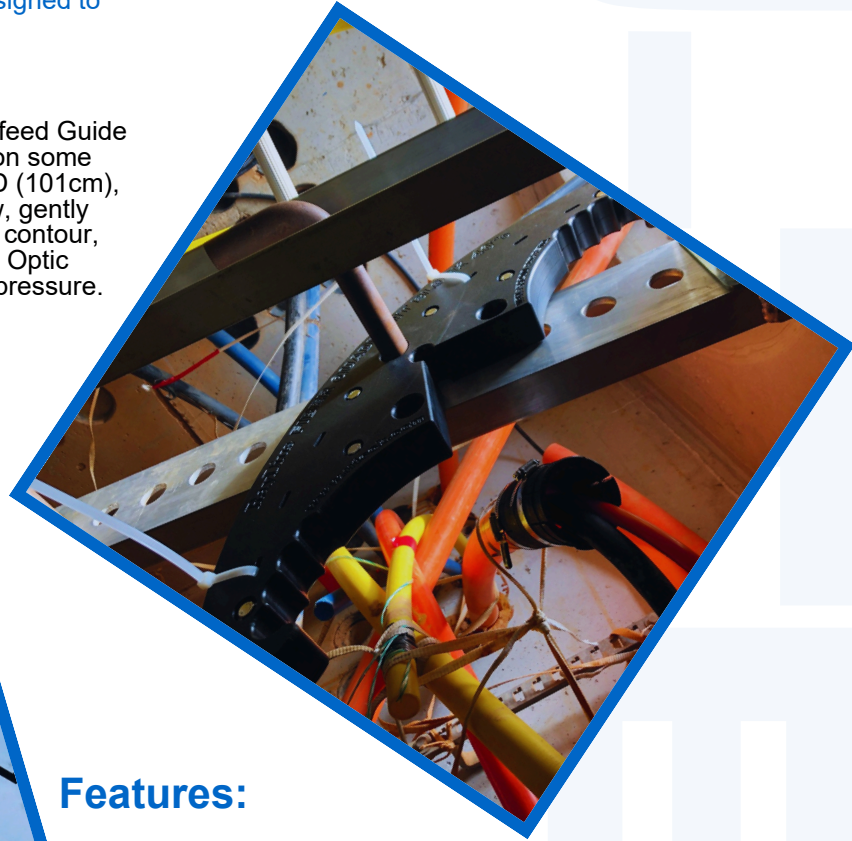

Features:

- Solid, Smooth, Cable Channel for consistent cable travel
- Lightweight, and Durable Design
- Ergonomic Grips for Safe Handling
- 6 Cable Keeper slots for securing cable
- All Stainless-Steel Hardware
- Minimum Bend Diameter and Max Load info clearly visible
- Fits most all existing Jamb Skids, Hanger Arms, Hanger Blocks, Support Bars, and Pole Brackets

Using a new, gently curving solid design we were able to provide a smooth contour, while maintaining the required bend radius of the Fiber Optic Cable, and eliminating breakage caused from contact pressure. This product will fit on all standard Jamb Skids, Hanger Arms, Hanger Blocks, Support Bars and Pole Brackets. The RayDius™ block has 6 unique Cable Keeper slots for using Deltec™ strapping or tie wraps when you want to ensure that the cable continues to travel over the block without bouncing off. Using proper tools, such as the RayDius™ will also greatly reduce man hours spent trying to resolve internal cable breakage issues. The RayDius™ is also safer to utilize and lightweight for easier maneuvering in small spaces with ergonomic grips molded into the design! Buy with or without the Ballistic Nylon Case!

Ordering Information

Product:	Description:	VPN:
RayDius™ Fiber Quadrant Block	9 Lbs	59200
Balistic Nylon Carrying Case w/ padded strap	3.8 Lbs	59225

QUADRANT BLOCK SUPPORTBAR

15

U-TECK's Quadrant Block Support Bar is ideal when using the RayDius Quadrant Block as a Lip Roller on the edge of a manhole or handhole.

This Multi- Position design also works well off the grounds surface to ensure proper cable travel. Additional bars can be attached for extra stability. This Support Bar holds the Quadrant Block in place while pulling and guiding fiber cables into or out of an underground duct, manholes, or handholes. Weighing just 6 pounds, this support bar in constructed of Non-Conductive materials and can be used with other Quadrant Blocks on the market as well. Each Support Bar Bracket has 2 rubber bumpers to prevent slippage once it has been positioned.



Features:

- All NON-CONDUCTIVE materials
- Lightweight, and Durable Design Can be used with most Quadrant Blocks Rubber
- Bumpers Prevent Slippage

Ordering Information

Product:	VPN:	Description:
Quad Block Support Bar	59300	5.5 Lbs

www.uteck.com | 1-800-542-7011

SuperJamb Jamb Skid

INTRODUCING THE ALL NEW U-TECK SuperJamb Jamb Skid! This product works with our RayDius Fiber Quadrant Block, Quad Block Support Bar and Quad Block Coupling Bar.

Our all new lightweight design makes cable placement in communications vaults easier than ever before! Gone are the bulky, cumbersome jamb skids of the past! The adjustable pressure bar provides side lateral support to ensure the SuperJamb Jamb Skid stays secure while in use.

Features:

- Lightweight and easy to use
- Extends from 73" to 114"
- No tools needed!
- Can be set up quickly by one person in minutes
- Provides secure mounting location for RayDius Quad Block, or sheaves, to ensure minimum bend diameter is met
- Adjustable positioning of Quad Block allows easy configuration for infinite pulling scenarios.
- Adjustable Pressure Bar provides Side Lateral Support
- Allows for more room while working in cramped and congested environments



Extends from 48" to 110"

Ordering Information

Product:	VPN:	Description:
SuperJamb Jamb Skid	55850	50Lbs

www.uteck.com | 1-800-542-7011

SUPERJAMB JAMB SKID FEATURES

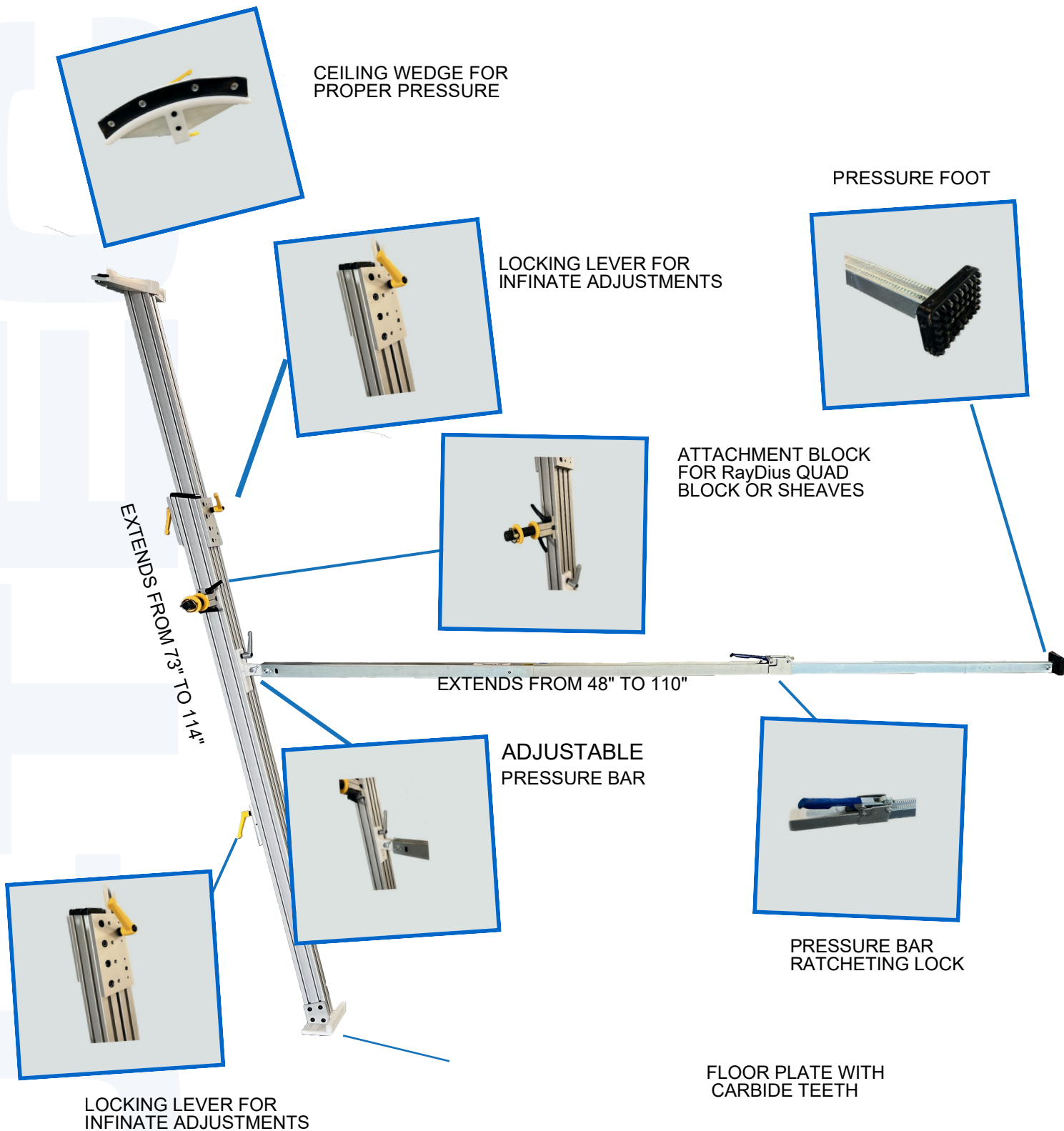

CABLE PULLING MESH GRIPS

U-TECK's Cable Pulling Grips provide an easy convenient means of pulling various sizes of Fiber Optic Cable.

Features:

- Extremely strong. (Rated up to 700 lbs.)
- Convenient pulling loop.
- Kevlar thread for stronger hold
- Safer than other metallic grips.
- 60" total length.
- Adds minimal overall diameter to cable while pulling.
- 2 color coded sizes for a wide range of cable diameter.
- Abrasion resistant.
- Minimal Fraying
- Grips Can be used repeatedly after inspection

Made with Dual Polymer and Kevlar Construction. Radial Compression holds cables tightly during pull.

*Always refer to your cable manufacturers recommended maximum pulling weights.

*Always test Pulling Loop & Grip Body for strength before re-using by sliding protective cover down to inspect the pulling loop and sliding back into place.

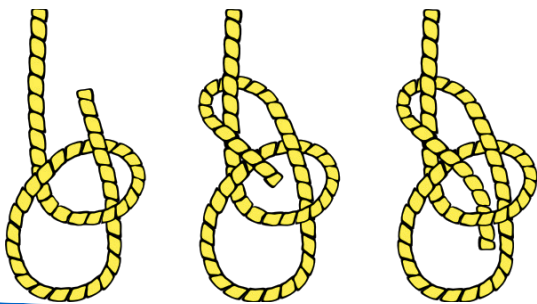

Ordering Information

Product:	Description:	VPN:
Cable Pulling Grips- Small	"Blue", Black 1/2" non-metallic mesh, used to pull cable sizes 3/8" to 3/4" diameter. Packages of 3.	GRIP-SM.50
Cable Pulling Grips- Large	"Yellow", Black 3/4" non-metallic mesh, used to pull cable sizes 3/4" to 1-1/4" diameter. Packages of 3.	GRIP-L.75

MESH GRIP BULK REEL

U-TECK's NEW Cable Pulling Mesh Bulk Reel provides an easy convenient means of pulling various sizes of Fiber Optic Cable. Our convenient bulk reel allows you to cut and fashion grips when needed.

Features:

- Extremely Strong (Rated to 700lbs)
- Adds minimal overall diameter to cable
- 2 sizes for a wide range of cable diameter Cuts cleanly with little fraying
- Abrasion resistant
- Minimal Fraying

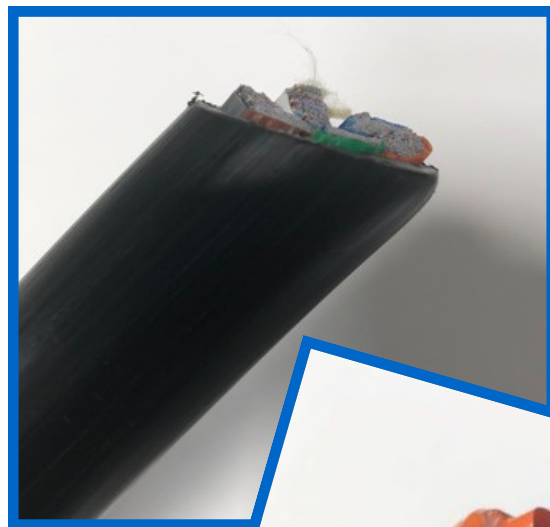

We recommend tying a simple bowline knot leaving a 3" minimum tail.

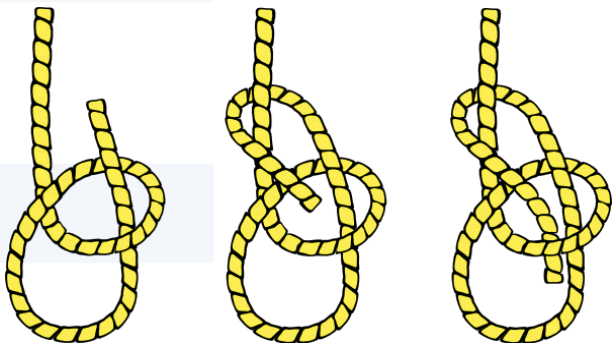

*Always refer to your cable manufacturers recommended maximum pulling weights. *Always test knot for strength before using! Pulling Sleeve Grips are also available in a package of 3!

Ordering Information

Product:	Description:	VPN:
Cable Pulling Mesh, Bulk Reel, Black, 1/2" x 100Ft.	Used to pull cable sized 3/8" to 3/4" diameters.	UT-MESH.50
Cable Pulling Mesh, Bulk Reel, Black, 3/4" x 75Ft.	Used to pull cable sizes 3/4" to 1-1/4" diameter.	UT-MESH.75

www.uteck.com | 1-800-542-7011

RADIUS BEND TOOL

U-TECK's Bend Radius Tool ensures the correct minimum bend radius of no less than 8" when installing #6 copper grounding wire. This tool helps safeguard proper grounding, and reduces risk of arc flash in a lightning event. Please keep bends at a 90 degree minimum.

Features:

- Easy, Convenient 8" Radius Guide
- Ensures installers stay up to Industry Standards with bends under 90 degrees and a radius less than 8" when installing bonding conductors
- Easily fits in any tool pouch
- Comes with built in level for using angles
- 8" reference is not just for mobility, it is a commonly recognized dimension across industries related to lightning surge protection

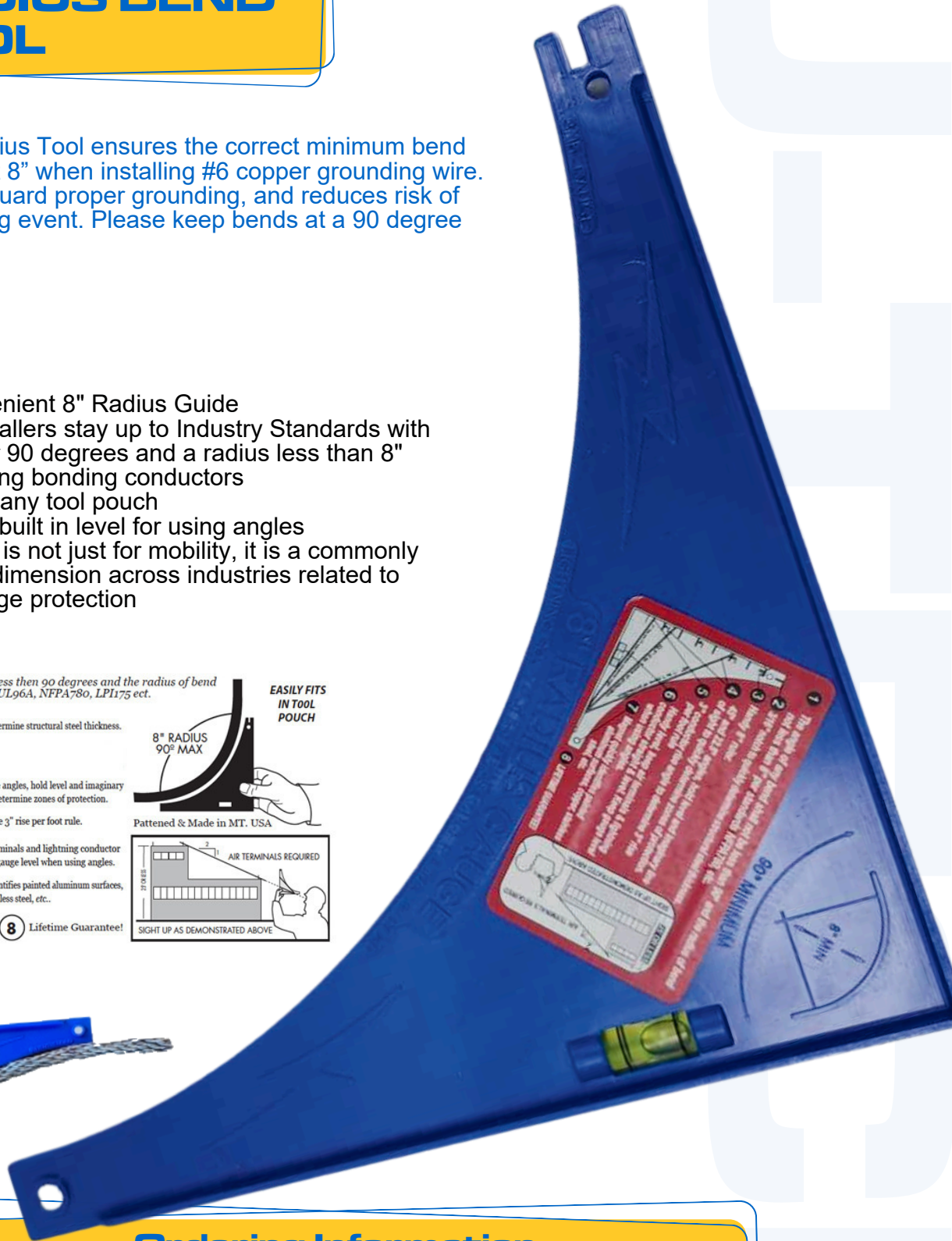
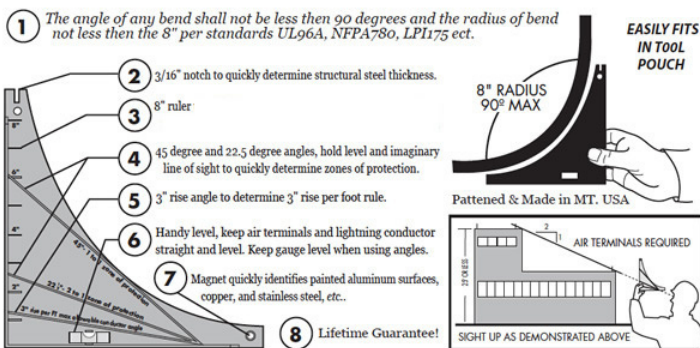

Ordering Information

Description:

Radius Bend Tool

Description:

Lightning Protection 8"
Radius Gauge

VPN:

UT-8124

CABLE REEL POLE BRACKET

21

U-TECK's Cable Reel Pole Bracket is necessary tool when deploying Aerial Fiber Optic, COAX cables or Pulling Tape. This Pole Bracket holds Fiber Cable Reels and Spools up to 36" in diameter, and 10" in width to the utility pole. This Pole Bracket is perfect for deploying drops.

Features:

- Easy to use & Versatile
- Holds Fiber Cable Reels up to 36" in diameter and 10" wide
- Works with Fiber Optic, COAX cables and pulling tape
- Fits on a variety of pole designs
- Comes with two 3" bushings to fit 1.25" or 3" diameter shafts



Simply attach the bracket using two, self-retracting ratchet straps. The frame shape design allows for a firm, non-slip grip on wooden poles of varying diameters, hexagonal shaped, composite, or steel poles. The Cable Reel Pole Bracket comes complete with a set of two 3" bushings designed to snugly fit onto the 1.25" diameter shaft. Since various cable manufacturers supply their drop reels with cores featuring either 1.25" or 3" internal diameters, rest assured that U-TECK has your needs fully addressed.

Ordering Information

Product:	Description:	VPN:
Cable PlacementPoleBracket	6 lbs	59350

www.uteck.com | 1-800-542-7011

FIBER DROP CADDY

U-TECK's Fiber Drop Caddy is designed for Fiber Drop Hand Coil optimization by making drops easier to manage. The caddy spools come in different sizes and are adjustable to accommodate various inside diameters of coils.

Features:

- Fiber coil easily attaches to caddy:
 - ONE carabiner included
- Can handle up to 1500' fiber drops!
- Lightweight
- Easy to Store
- Different spool sizes allow individuals to fit most coil sizes.



Spools are sold separately and are interchangeable

Options:

- Small - Non-Adjustable
 - 5" Spool
- Medium/Small - Adjustable
- 7", 8.5" Spool
- Medium - Adjustable
 - 10", 10 3/4", and 11 1/2" Spool
- Large - Adjustable
 - 12 3/4", 13 3/4", 14 3/4", 15 3/4" Spool

This caddy can also be used to pay out fiber coils, wire, or pull tape, that are already on a core with a 1.25" inside diameter and a 5.25" wide width, by using the spindle only.

Ordering Information

Product:	Description:	VPN:
Small	5"	59016-S
Medium Small	7", 8.5"	59016-MS
Medium	10", 10.75", 11.5"	59016-M
Large	12.75", 13.75", 14.75", 15.75"	59016

(28 lbs when empty)

www.uteck.com | 1-800-542-7011

FIBER DROP CADDY INSTRUCTIONS



Remove the spool from caddy frame by sliding the spool assembly out.

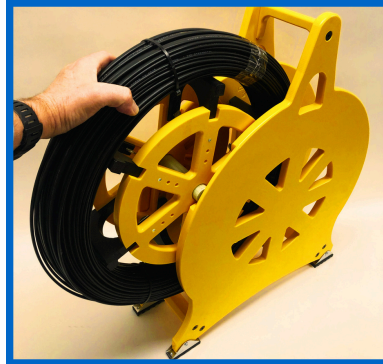

DO NOT remove the ties or plastic packaging until the coil is attached to the caddy and ready to use.



Determine the inside diameter of the fiber cable to be used.



There are pre-determined positions by which the spools can be adjusted.

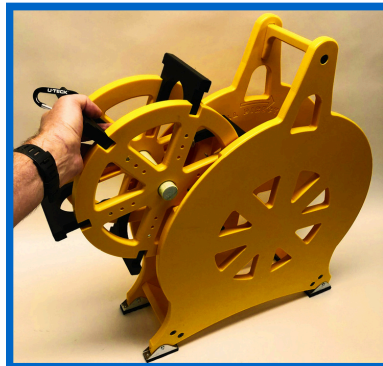

Slide the spacers to the desired spool diameter by removing the thumb screw and reinserting in the desired position.



Attach the inside of the coil to the spool by using the carabiner (*included*) or tie wraps (*not included*).



Reinsert the loaded spool into the caddy frame.

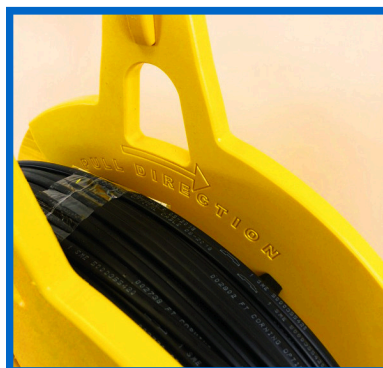

The payout direction is indicated inside the frame.



Level surfaces recommended, but the pivoting feet allow use on uneven surfaces.

FIBER COIL TURNTABLE

The BRAND NEW Fiber Coil Turntable is for use in the field when fiber coil deployment is difficult, and there is a MFT/MST attached to the coil.

No more worry about spring back or backlash - the FCT eliminates those problems! U-TECK's Fiber Coil Turntable is an essential tool for Managing Loose Fiber Coils for Trouble-free Rapid Deployment. This versatile device can be used for loose Terminated Coils of up to 1500' with or without MST/MFTs attached. The Turntable also works great with spooled Fiber Cable on reels, CAT 5/6 cable, COAX cable, and even dispensing Pull Tape or Pull Rope. Quickly disassembles for easy storage

Features:

- Reduces Fiber Coil Spring back
- Easily adjustable for multiple size coils
- Rubber Cleats affixed underneath to prevent slipping
- Metal Stakes included for when working in grass etc...
- Adjustable brake for increasing tension and reducing Drag & Backlash
- Handles on each corner for easy transport
- Alignment Guides for determining proper ID



(Shown with Turntable Spindle Accessory)



Ordering Information

Product:	Description:	VPN:
Fiber Coil Turntable Turntable	33Lbs	59020
Spindle	2.2Lbs	59020-Spindle

www.uteck.com | 1-800-542-7011

FIBER COIL TURNTABLE INSTRUCTIONS

25



You will receive the parts shown with your Fiber Coil Turntable Kit.



Remove the MFT/MST tray to expose the turntable.

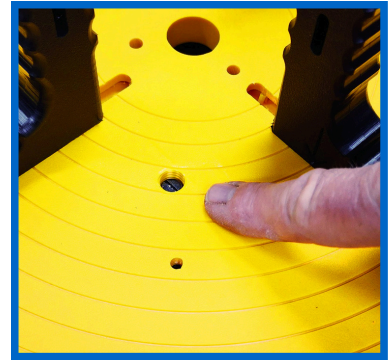

The turntable spinning rate can be adjusted to add more drag by adjusting the large screw.



Determine the Internal Diameter by measuring the coil.



Adjust the 4 coil stops by loosening the knobs, sliding the stops inwards or outwards and adjusting them to the proper ID by aligning the arrow on each stop to the corresponding circular diameter guide.



Lower cable onto coil stops. For larger diameter cables, reverse the footing on the coil stops.



Reattach the MFT/MST tray by aligning the tray over the stops. The tray rides onto the cable and adds pressure to the coil as the coil is unwound.



Using the 2 Velcro straps, secure the MFT/MST to the tray.



Remove the bindings once you are ready to unwind the coil. *Ground stakes are available if needed by inserting them at each corner.

REEL DEAL CABLE CADDY

Storing, transporting, and using your cable reels and pull lines on-site is no longer a multi-step process. With the new U-TECK Reel-Deal™ Reel Caddy, you can do all of this with one simple tool.

Features:

- Constructed from 3/4" impact resistant plastic
- High visibility safety yellow
- Quick release spindle construction for easy reel loading
- Pivoting, rubber feet and wide base prevents sliding or tipping
- Compact design perfect for storage and transport
- Made in America



Made from solid 3/4" impact resistant plastic, the Reel-Deal™ can handle the everyday wear and tear all of your equipment is subjected to, and then some. The non-fading safety yellow color gives you extra visibility. Notched handle makes for easy pick-up and go!

Whether you do work for telecoms or CATV's, the Reel-Deal™ Reel Caddy is ready to go to work for you.

Ordering Information

Product:	Description:	VPN:
Safety Yellow Reel-Deal™ Reel	20.5" W x 20"Hx16"D	59000

REEL DEAL SINGLE LINE PULL CADDY

Storing, transporting, and using your cable reels and pull lines on-site is no longer a multi-step process. With the new U-TECK Reel-Deal™ Reel Caddy, you can do all of this with one simple tool.

Features:

- Constructed from 3/4" impact resistant plastic
- High visibility safety yellow
- Quick release spindle construction for easy reel loading
- Pivoting, rubber feet and wide base prevents sliding or tipping
- Compact design perfect for storage and transport
- Made in America



Made from solid 3/4" impact resistant plastic, the Reel-Deal™ can handle the everyday wear and tear all of your equipment is subjected to, and then some. The non-fading safety yellow color gives you extra visibility. Notched handle makes for easy pick-up and go!

Whether you do work for telecoms or CATV's, the Reel-Deal™ Reel Caddy is ready to go to work for you.

Ordering Information

Product:	Description:	VPN:
Safety Yellow Reel-Deal™ Single	11.25 LBS., 14-1/2" L x 18" W x 23" H	59011

HI-ROLLER CABLE PLACEMENT WHEELS AND ACCESSORIES

U-TECK's Hi-Roller Aerial Cable Placement Wheels are a critical tool used to prevent cable damage while placing Fiber Optic, Coax, and other self-supporting cable

Features:

- Available in two sizes: 24" and 12"
- Lightweight construction
- Dielectrically Safe for Aerial use
- Multi positional swivels for a wide range of pulling angles
- Loading cables is fast and easy
- Easily attached and loaded in seconds
- Lightweight and capable of handling loads not to exceed 1000 lbs.
 - *Fiber Optic Cable recommended load rating is 600LBF*

The Hi-Roller comes with a 3/8" Stainless Steel, multi-swivel slip hook for smooth cable transitions of any angle. Simply attach to suitable existing pole line hardware, or use the "Hi-Roller Pole Strap" (pictured below).



Pole Strap Features:

- Secures the Hi-Roller Aerial Cable Wheels to utility poles or other secure structures.
- Quick Cinching Buckle
- 1.5" Nylon Strapping
- Stainless Steel D-Ring

Hi-Roller Tripod Features:

- Attaches to the 12" Hi-Roller
- Adjustable height from 4 to 7 feet
- Adjustable legs for uneven terrain
- Stakes and leg attachments are included to help stabilize the tripod
- Saves time and personnel when setting up a long pull
- Set up additional tripods for sequential handhole-to-handhole installations

12" Hi-Roller

Hi-Roller Tripod



Accepts cables less than .75" in diameter

24" Hi-Roller



Accepts cables less than 1.5" in Diameter

Ordering Information

Product:	Description:	VPN:
Hi-Roller Cable Placement Wheel 12"	6lbs	59412
Hi-Roller Cable Placement Wheel 24"	18.6 lbs	59424
Hi-Roller Pole Strap	1Lb.	59401
Hi-Roller Tripod	7.5lbs	59410



Attach Hi-Roller to existing pole line hardware or pole strap (VPN 59401)



Remove retainer pin



Separate two halves of frame as shown



Allow frame to hang freely (as shown)



Place cable onto wheel



Re-insert retainer pin

HI-ROLLER CABLE PLACEMENT WHEEL INSTRUCTIONS

1. Simply position the tripod over the hand hole.
2. Attach the Hi-Roller Placement Wheel to the eye bolt under the top plate.
3. Attach cable to the Hi-Roller Placement Wheel and pull easily from Handhole to Handhole.
4. Set up additional Tripods as needed.



FIRE RETARDANT INTERIOR BACKBOARDS

U-TECK manufactures a full line of Fire Retardant Backboards for Telecom and Datacom equipment Installations. Check your local building codes and requirements. These backboards make installations quick and uncomplicated for technicians and contractors on the move and come ready for interior or exterior applications!

**Comes in White or Gray / Low Maintenance / Moisture and Termite Proof
ASTM Certified / UV Stable / No Splitting or Cracking**

Our back boards are constructed of $\frac{3}{4}$ " AC grade interior plywood purchased from sustainable forest wood manufacturers. They have 4 pre-drilled mounting holes, are sanded and then painted with gray or white fire retardant intumescent paint. The board is Class "A" rated per ASTM E84 (testing documentation available upon request). Our finished backboards are of the finest quality, and we have supplied backboards without any safety concerns or complaints regarding quality and reliability. By specifying U-TECK Backboards, you can be sure you will uphold the quality and safety standards of your company while meeting today's construction guide lines.

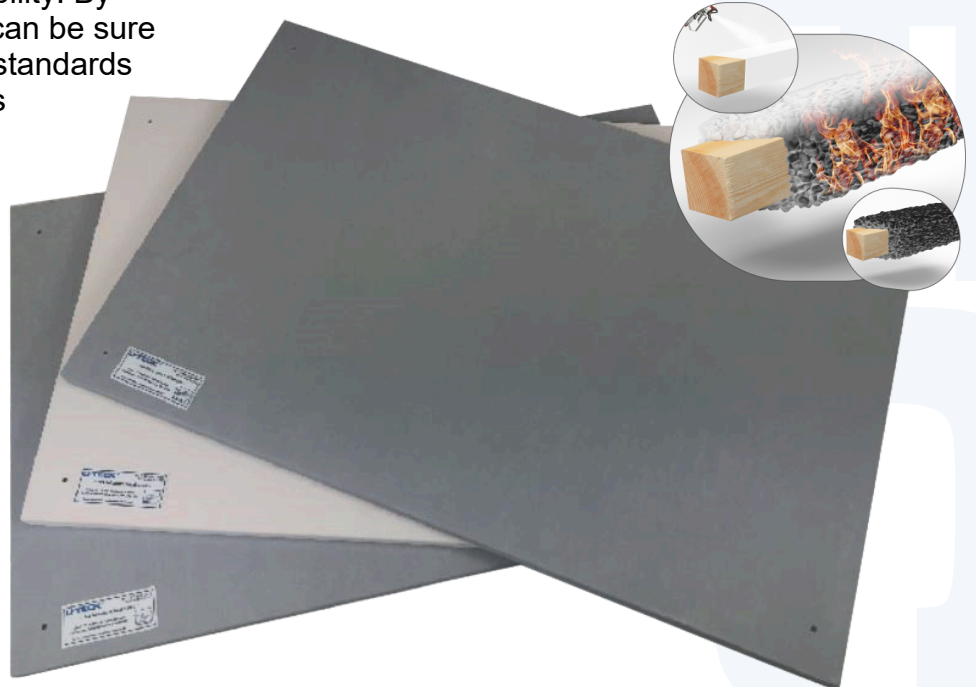

Offering the highest quality products available is always our top priority. This objective was never taken more seriously than when we were approached to produce a fire-retardant backboard for use with telecommunication equipment. While other manufactures offer products using just the paint testing to prove fire retardancy, we aimed for a Class "A" rating for the entire backboard! We submit random backboards to an outside testing lab to continuously test our finished units using the Steiner tunnel test. This test is conducted in accordance with the ASTM International fire-test response standard E84, to ensure our finished products can be labeled as Class "A" rated, the highest rating available within that ASTM specification. Every U-TECK Fire-Retardant Backboard comes with this Class "A" rating, along with the Class Rating Label affixed to each board! That makes ours the safest backboards available in the market today!

U-TECK recognizes the need for long-lasting material construction when choosing a backboard for outdoor use. Nature itself can be a brutal force, with outdoor backboards being exposed to fluctuating temperatures, rain, wind, and hours of direct sunlight. When you choose an outdoor backboard, choose one that will outlast standard wood backboards for years of low maintenance use.

Features:

- Constructed from 3/4" impact resistant plastic
- Paintable and ready to install
- Low maintenance
- Moisture and termite proof
- A size for every job
- No grain raise or knots
- No splitting or cracking
- UV stable
- Meets UL94 5V, UL 1975 and has a flame spread of 20 according to ASTM E84

Made from 3/4" impact resistant plastic, our Exterior Backboards are super tough and moisture proof. Available in any size configuration, this backboard will never rot, split or crack, yet can be drilled and painted like wood.

It is perfect for any outdoor mounting use, including on cell towers to mount communication and power equipment.

Why mount your equipment to backboards that will need to be replaced due to constant weather exposure? Choosing the right tool for the job guarantees you'll save your company time and money.

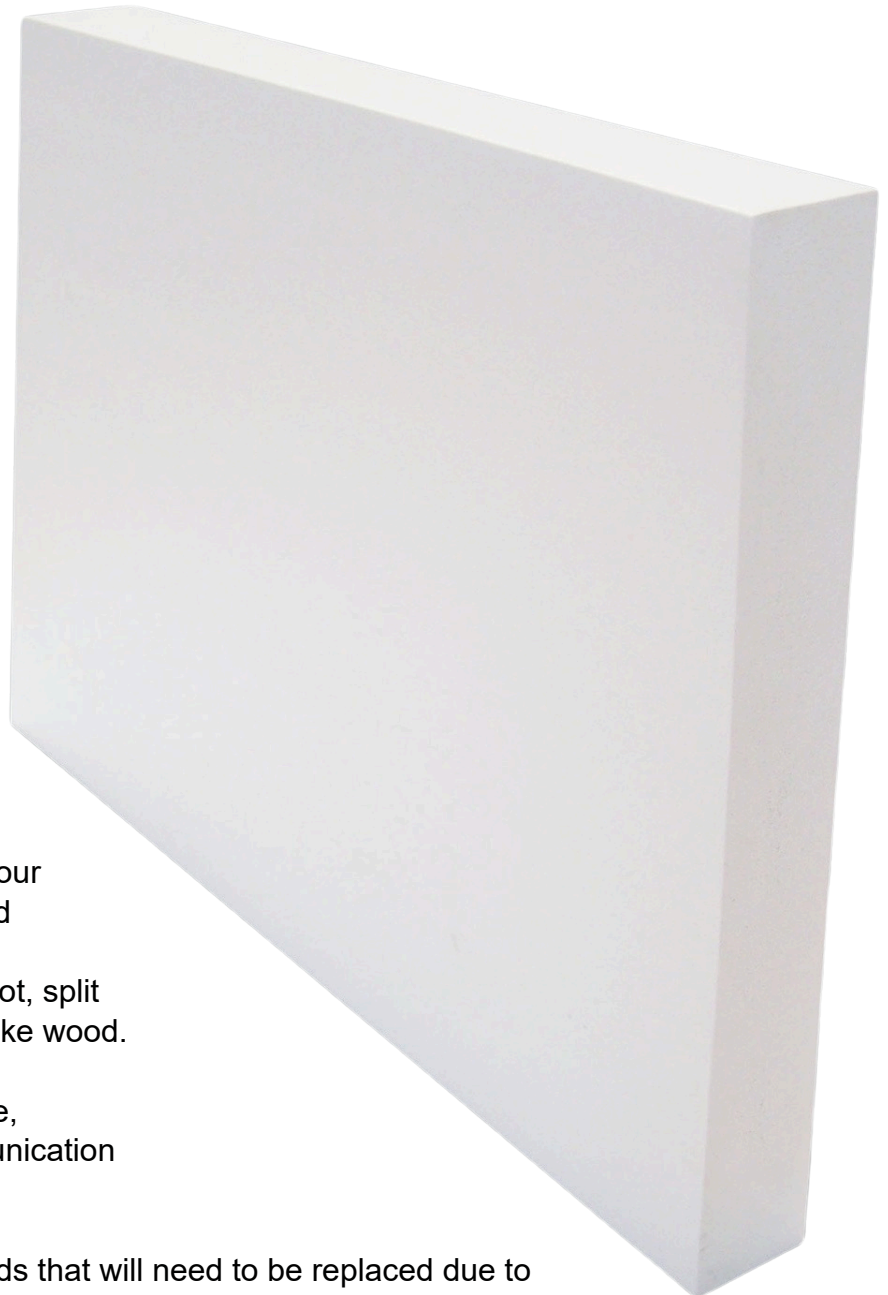

Backboard Specifications

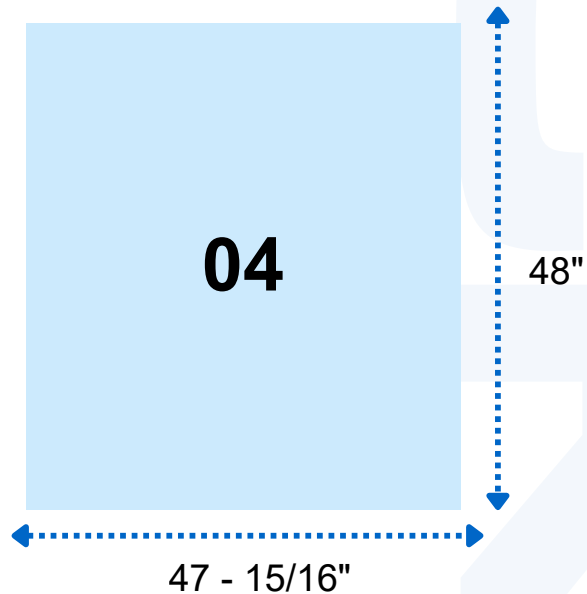
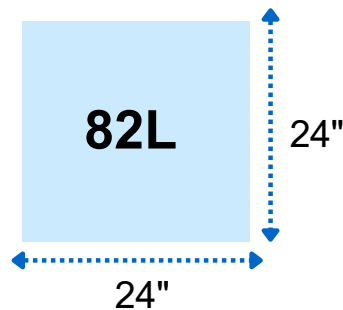
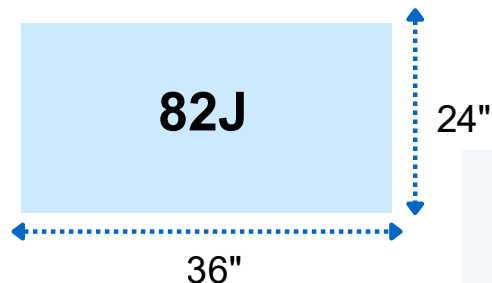
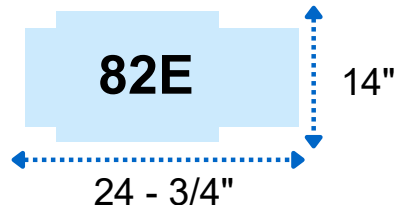
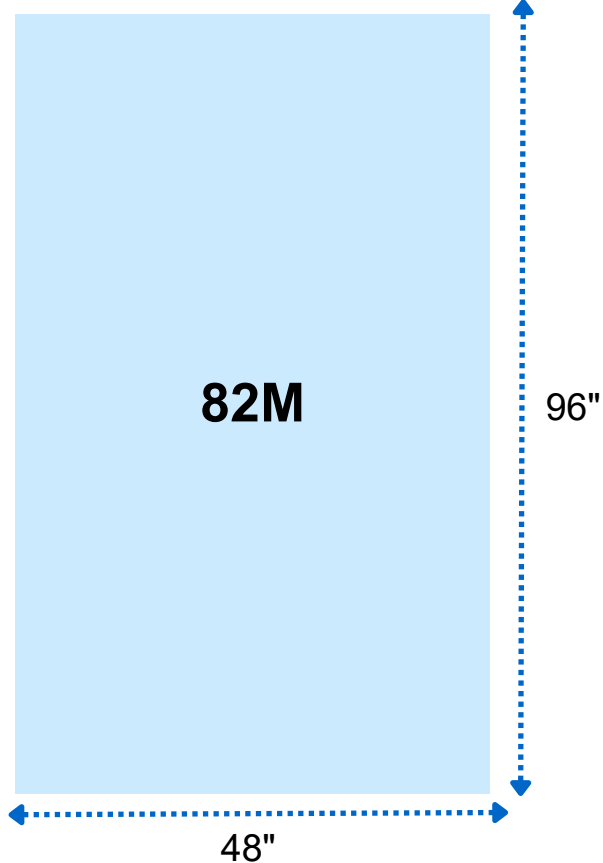
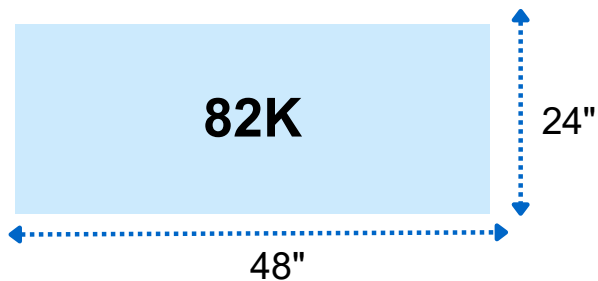
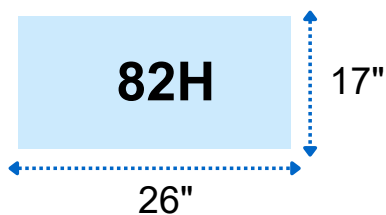
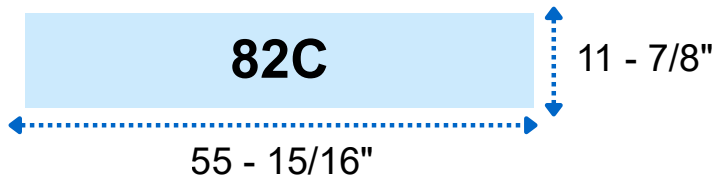
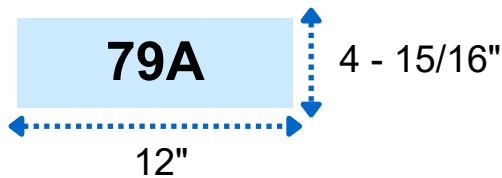

Ordering Information

Fire Retardant Gray



Product :	Model :	Size:
50104-FR	04	47 - 15/16" x 48" x 3/4"
501079A-FR	79A	4 - 15/16" x 12 - 1/2" x 3/4"
501081-FR	81	12 - 1/2" x 25 - 1/2" x 3/4"
501082A-FR	82A	6 - 3/4" x 38 - 1/2" x 3/4"
501082B-FR	82B	9 - 3/8" x 54 - 7/8" x 3/4"
501082C-FR	82C	11 - 7/8" x 55 - 5/8" x 3/4"
501082D-FR	82D	6 - 3/4" x 21 - 3/8" x 3/4"
501082E-FR	82E	14" x 24 - 3/4" x 3/4"
501082F-FR	82F	14" x 24 - 3/4" x 3/4"
501082G-FR	82G	9 - 3/8" x 63" x 3/4"
501082H-FR	82H	17" x 26" x 3/4"
501082J-FR	82J	24" x 36" x 3/4"
501082K-FR	82K	24" x 24" x 3/4"
501082L-FR	82L	24" x 24" x 3/4"
501082M-FR	82M	48" x 96" x 3/4"

Fire Retardant White



Product :	Model :	Size:
50104-FRW	04	47 - 15/16" x 48" x 3/4"
501079A-FRW	79A	4 - 15/16" x 12 - 1/2" x 3/4"
501081-FRW	81	12 - 1/2" x 25 - 1/2" x 3/4"
501082A-FRW	82A	6 - 3/4" x 38 - 1/2" x 3/4"
501082B-FRW	82B	9 - 3/8" x 54 - 7/8" x 3/4"
501082C-FRW	82C	11 - 7/8" x 55 - 5/8" x 3/4"
501082D-FRW	82D	6 - 3/4" x 21 - 3/8" x 3/4"
501082E-FRW	82E	14" x 24 - 3/4" x 3/4"
501082F-FRW	82F	14" x 24 - 3/4" x 3/4"
501082G-FRW	82G	9 - 3/8" x 63" x 3/4"
501082H-FRW	82H	17" x 26" x 3/4"
501082J-FRW	82J	24" x 36" x 3/4"
501082K-FRW	82K	24" x 24" x 3/4"
501082L-FRW	82L	24" x 24" x 3/4"
501082M-FRW	82M	48" x 96" x 3/4"

Shown above are our most common sizes...we have many more available and are able to manufacture custom size backboards to meet your specifications.

CANOPY TENT

U-TECK's Canopy Tent comes with adjustable legs for a quick and easy set up.

A simple shelter that is adaptable to a wide range of worksites and weather conditions. Sturdy fiberglass and steel frame with coated polyester cover provides UV protection and water repellency. Flame retardant to CPAI 84 standards. Adjustable legs can easily adjust from 62" up to 88". White roof and safety green valance.



Features:

- Quick and easy set-up
- Many safety features
- Lightweight & compact
- Full circulation
- Non-corrosive hardware
- CPAI 84 Compliant
- Will not mildew
- Accessories Available

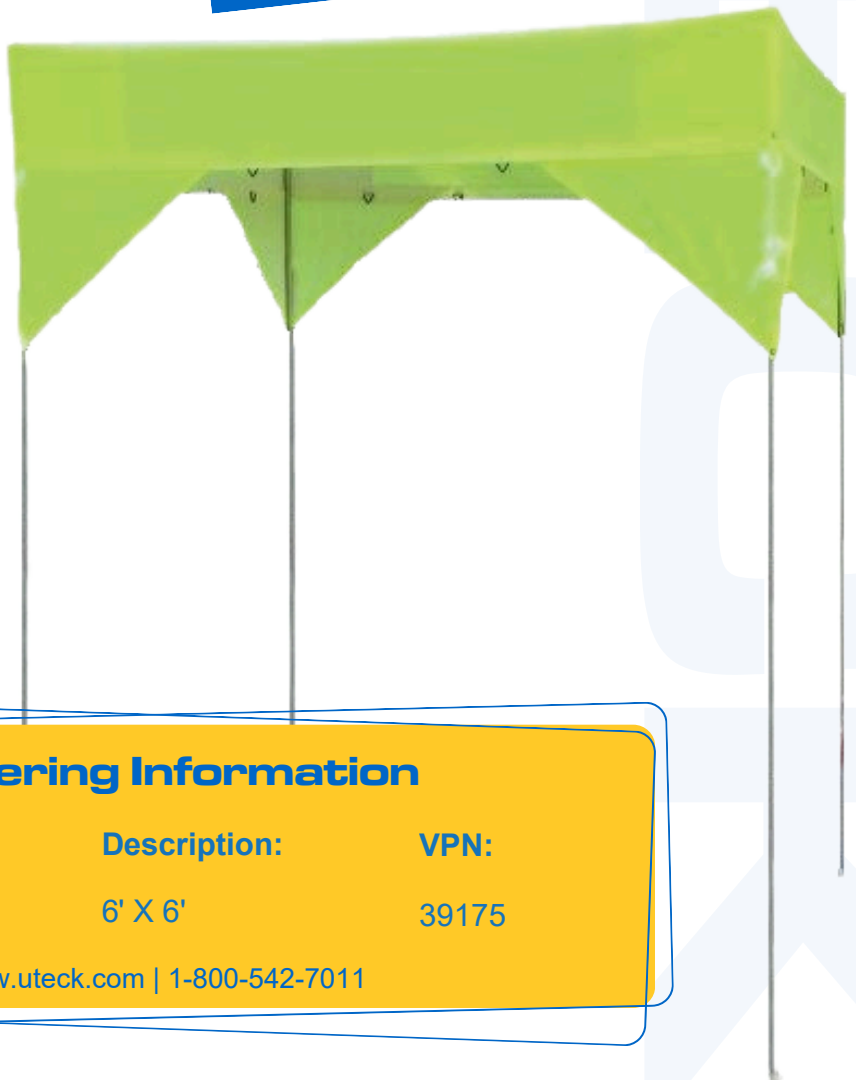

This product is perfect for a wide range of work sites such as:

- Pedestals
- Handholes
- Open Trenches
-and so many more

Ordering Information

Product:	Description:	VPN:
CANOPY TENT	6' X 6'	39175

www.uteck.com | 1-800-542-7011

CANOPY TENT Accessories

35

U-TECK also offers accessories for our canopy tents (3) Sidewalls and a storage bag.

Add the optional Removable 3 Wall Set and place next to buildings and structures for a fully enclosed work shelter. The removable wall sections attach with velcro and snaps and provide additional protection from wind or rain when needed.

Equipped with long Velcro straps on top and sticky Velcro on the sides, these sidewalls can be easily attached to your canopy and provide a firm and reliable hold.

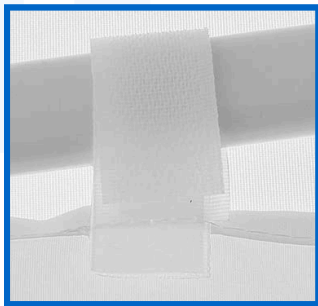

To be attached to the frame more sturdily with a widened paste area



Rust proof zipper that smoothly connects sidewall to sidewall



Velcro's can be attached solidly.



To be attached to the leg so the sidewall and the leg are connected tightly.

The optional Storage Bag will protect the canopy and side walls from damage during storage and transport



Ordering Information

Product:

REMOVABLE WALLS (X3)
STORAGE BAG

VPN:

39176
39177

www.uteck.com | 1-800-542-7011

COLD WEATHER TENT

Cold Weather Tents set up in seconds with no loose parts. The tents unified frame made with cold rolled steel and fiberglass is virtually unbreakable.

Features:

- One door tent with single split zipper door
- 9" X 16" vent window in the back
- 10" blower port in the back
- 12" ground flaps on two sides
- 14" windlines on two sides
- Quick-pak storage wrap for easy storage

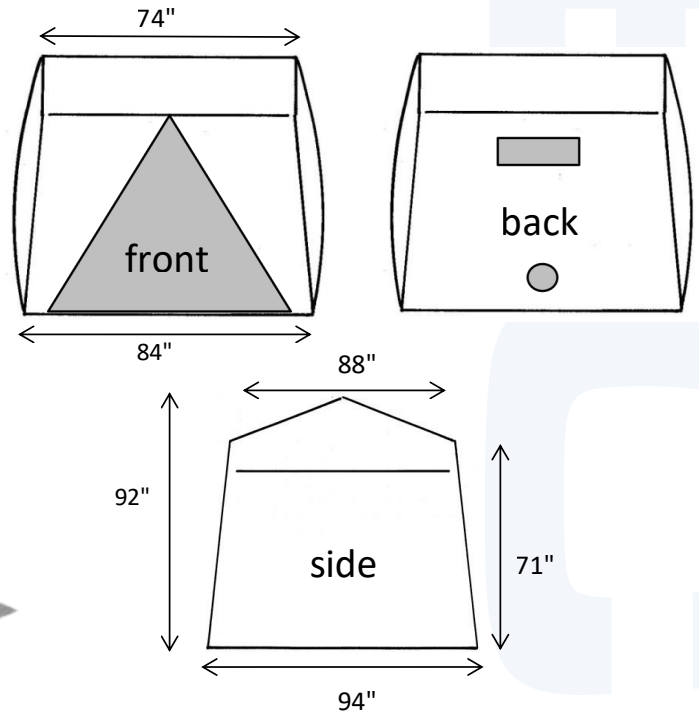

Ordering Information

Product:	Description:	VPN:
COLD WEATHER TENT	52 lbs., 8' x 7'	39167

U-TECK has developed the Vent-Tent, a portable shelter with more safety features than any other manufacturer currently has available in today's market

VENT TENT

37

Features:

- Quick and easy set-up
- Many safety features
- Lightweight & compact
- Full circulation
- Non-corrosive hardware
- Reflective sides
- No preshrinking
- Will not mildew
- 10" Blower Port in back

SPECIFICATIONS - 6' x 6' FOOTPRINT

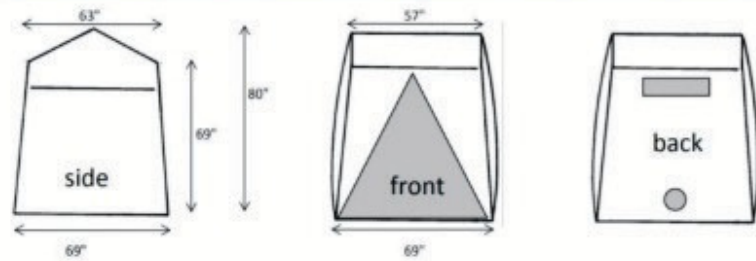

The Vent-Tent is specially designed to safeguard the craft person from fatal carbon monoxide build-up. The standard features that U-TECK installed allow air to be fully circulated by the following methods:

U-TECK has also installed a "sock" in the back of the Vent-Tent to allow for a ventilator hose, blower, or heater-blower combination to be hooked up.

In addition to carbon monoxide protection, the Vent-Tent, with its roll-up bottom and side windows, is excellent on hot, rainy day

Three of the sides have a lower-level vent, which allows for up to 18 inches of opening for air circulation at ground level. Two of the sides have a window, which may also be opened for upper-level air circulation.

The combination of open lower-level vents and open windows allows for cross-ventilation, which eliminates the possibility of fatal carbon monoxide build-up.



Ordering Information

Product:	Description:	Product:
VENT TENT	6' x 6'	39170-G

www.uteck.com | 1-800-542-7011

MANHOLE TENT/FTTH

U-TECK's FTTH Manhole Tents offer easy set up in seconds with no loose parts. The tents unified frame made with cold rolled steel and fiberglass is virtually unbreakable.

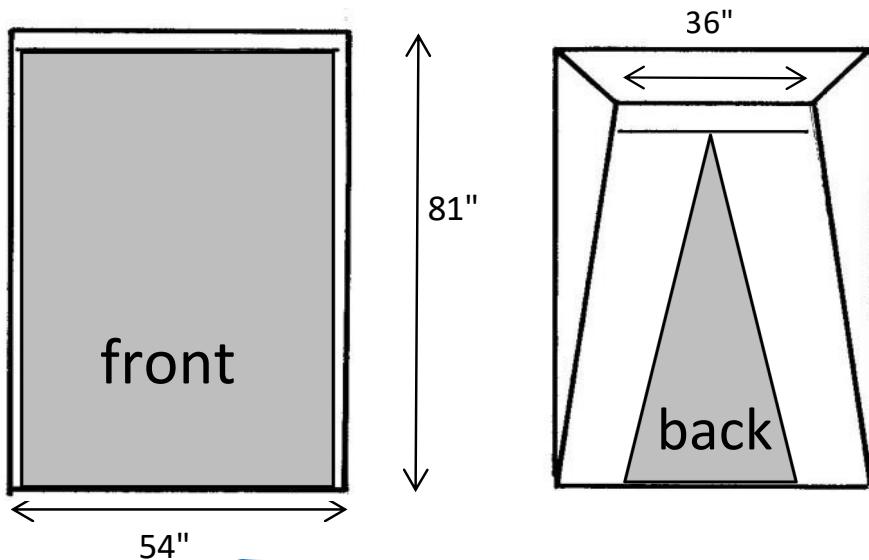
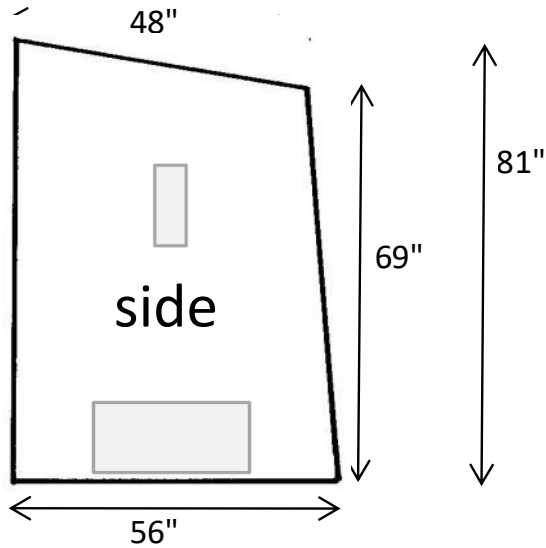

Features:

- Two door tent with front full width roll-up door and split back zipper door
- 24" X 12" safety vents on two sides
- Winch access panels
- 12" ground flaps on two sides
- 14' wind lines on two sides

Ordering Information

Product :	Description:	VPN:
MANHOLE TENT	27 lbs., 81" X 54" X 56"	39169

Maintenance crew members have thousands of miles of utility lines to cover in order to maintain all non-exempt equipment.

For example, one utility company states that maintenance crews are responsible for inspecting and removing flammable material within a 12' foot radius around approximately 120,000 poles and transmission structures in State Responsibility Areas. These numbers continue to increase every year as more and more people move to rural areas and new power lines are added to support new communities. That's a lot of ground to cover!

Features:

- Fire-Retardant
- Prevents Vegetation Growth
- 15 Year Warranty
- Easy to Maintain
- No Herbicides
- Easily Cut To Fit Any Area

So, how do you handle the ground level vegetation? Herbicides? Lawn mowers? Weed-whackers? Raking? All of the above?

There is an easier way! We've created the WeedEnder Utility Pole Mat, a fire-retardant mat that provides vegetation control within a 12' radius around the pole.

A mat so strong and durable that it carries a 15 year warranty!

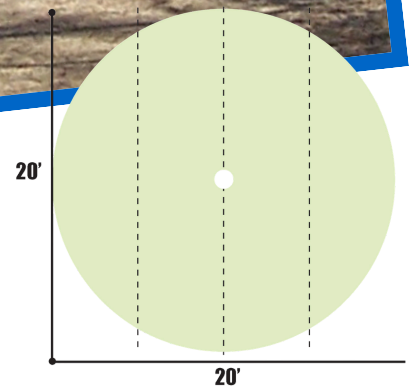
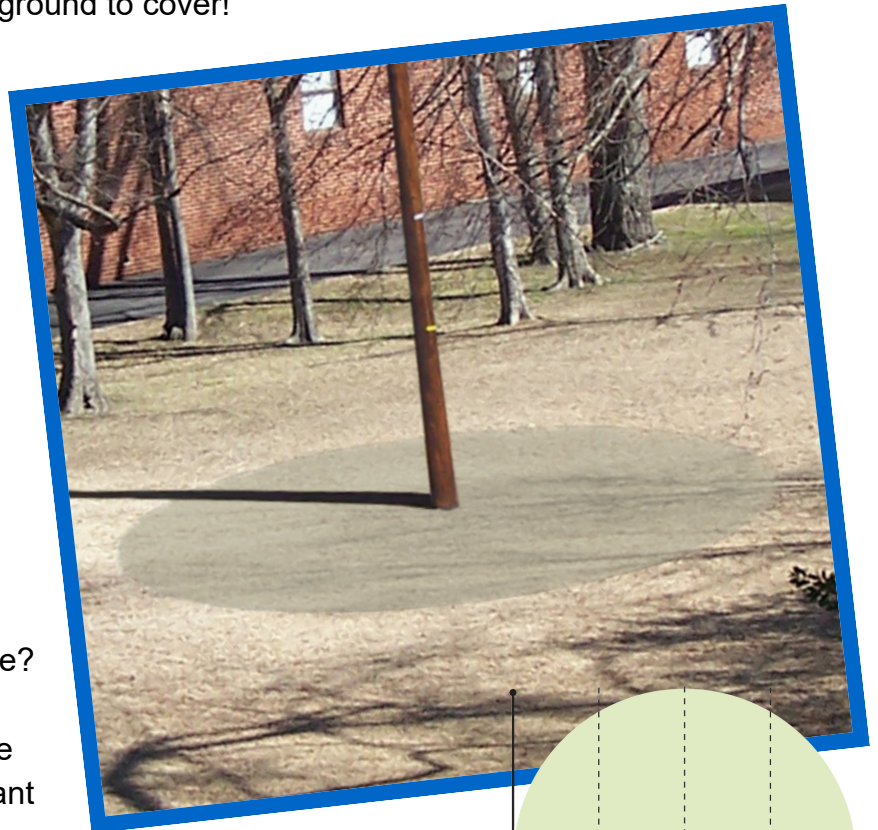

Ordering Information

Product:	Description:	VPN:
Utility Pole Kit	(includes 70 hook stakes, 1 joining strip, and 2 adhesive tubes)	76022K-G

www.uteck.com | 1-800-542-7011

PED MAT

U-TECK has developed a herbicide-free alternative to control unwanted vegetation around pedestals. The solution is now known as WeedEnder™ Ped-Mat.

Features:

- Fire-retardant
- Long-lasting 15 year warranty
- Improved visibility, reduces damage
- Easy to install
- Made from Recycled Plastic
- No Runoff
- No herbicides



Ped-Mats increases visibility around your pedestals. You get all of these benefits without the burden of weed-eating or unsightly herbicide use.

WeedEnder™ is also available in rolls for a larger coverage area. Rolls can be from 1 ft to 8 ft wide, and up to 250 foot length.

Installation is simple. Determine the size of the pedestal and cut the Ped-Mat along the appropriate perforated lines and stake in place.

Before & After Ped Mat Installation



PED MAT SPECS

- Ped-Mat 1 is die-cut and perforated to fit around most round pedestals.
- Ped-Mat 2 is die-cut and perforated to fit around most square or rectangular pedestals.
- Ped-Mat 3 is not die-cut and fits in those hard-to-fit areas, such as next to poles, other pedestals, or other obstructions. You cut to fit.

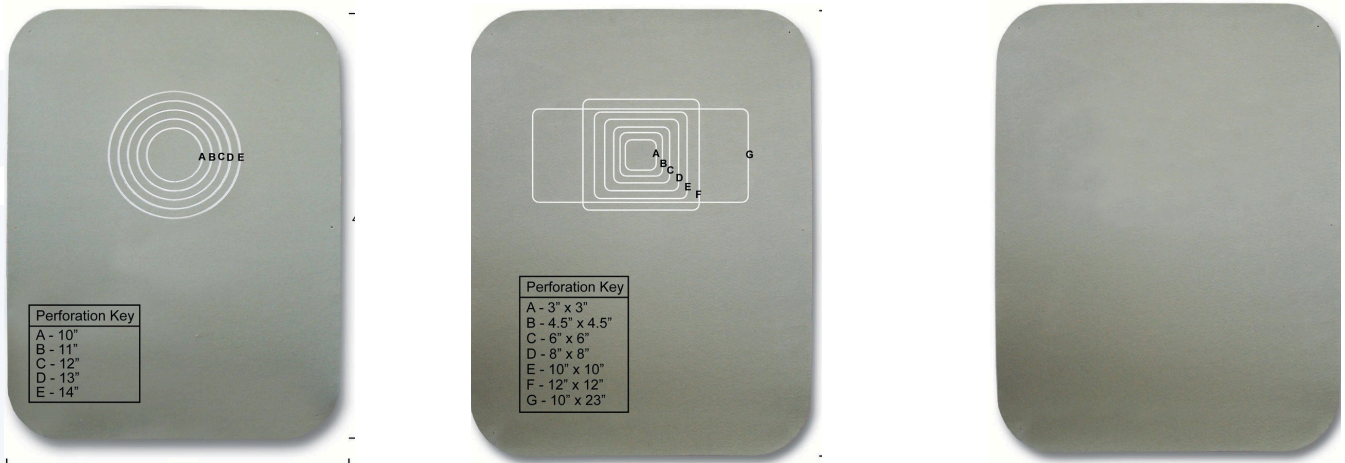

WeedEnder™ Rolls: Available in 3' and 6' Width X 25' length. Longer rolls are available. Joining Strip is a 4" x 25' strip to join (splice) the WeedEnder™ rolls. Hardened Steel General Purpose Spiral Spikes are 6" long and are designed to hold the mat in place. Packed 100/Box. 316 Stainless Steel Staples measure 1 1/4" x 5/8" and are packed 2,000 per box. These are used to join two widths of WeedEnder™ material with the joining strip. Manual Staple Gun holds 150 stainless steel staples and is pre-set to allow staple penetration through the material for splices and repairs. Adhesive/Caulk is specially formulated for primerless adhesion to the WeedEnder material and the metal or wooden guardrail posts (in wet or dry conditions) to inhibit weed growth.

Ordering Information

Product:	Description:	VPN:
Ped-Mat 1 - 3' x 4'	37 lbs.	74001-G
Ped-Mat 2 - 3' x 4'	37 lbs.	74002-G
Ped-Mat 3 - 3' x 4'	37 lbs.	74003-G
Green Roll - 3' x 25'	17 lbs.	74203-G
Green Roll - 6' x 25'	34 lbs.	74006-G
Joining Strip - 4" x 25'	2.5 lbs.	74403-G
Gen. Purpose Spiral	8 lbs.	74000
Spikes 316 SS Staples	3.8lbs.	74100
Manual Staple Gun	4.4 lbs	74200
Adhesive/Caulk (tube)	10 lbs.	8ADHESIVE-W

STREET SAVER & STREET SAVER SLIM TEMPORARY MICRO TRENCH PROTECTORS

U-TECK's New "Street Saver" and "Street Saver Slim" Micro-Trench Protectors gives Fiber Optic Contractors added protection on their Saw Cuts, keeping the trench open and preventing edge breakage, prior to back filling. These are great for high pedestrian areas and won't cause issues for bicyclists or strollers

Features:

- Helps Prevent Edge Breakage Prior to Back Filling
- Two lengths available – 4' and 8'
- Two widths available - 6" and 12"
- 2.5" silicone coated 'fins' keep the product in place
- Street Savers Interlocked for Extended spans
- Sloped Edges on each side for Easy Ingress and Egress
- Constructed from HDPE - will not Break or Crack
- UV stable
- Results in a Cleaner Looking Finished Product

Two lengths and widths are available to assist in complete trench coverage, and linking The "Street Savers" together is simple using our interlocking design, which also allows for flexibility when micro-trenches are cut along curves.

For higher speed traffic or overnight construction, there are 6 holes which can be used for temporarily screwing or bolting the Street Savers into place if necessary.

The "Street Saver" is Constructed from High Density Poly Ethylene (HDPE), will not break or crack under heavy traffic and are UV Stable. The Hi-Vis HDPE ensures increased motorist awareness to the construction zone. The Sloped Edges ensure ease for Ingress and Egress.

The "Street Savers" were designed to stay in place by utilizing the $\frac{3}{4}$ " fins located underneath the product. These silicon coated fins sit into the Micro Trench, ensuring the Micro-Trench Protectors will stay firmly in place.



Ordering Information

Product :	Description :	VPN:
Street Saver Micro-Trench Protector	25 Lbs., 12" x 96"	29096
Street Saver Micro-Trench Protector	12.5 Lbs., 12" x 48"	29048
Street Saver Micro-Trench Protector SLIM	6.5 Lbs., 6" x 48"	29048-S
Street Saver Micro-Trench Protector SLIM	13 Lbs., 6" x 96"	29096-S

MICRO-TRENCH TAMPER TOOL

The increase in fiber deployment initiatives have created the need for more cost effective ways of managing the task of fiber installation. Micro-trenching is one such solution

Micro-trenches are low impact slot cuts into roads, sidewalks, etc, in which fiber is placed. This method offers quick and easy install, clean-up and surface repair, especially in urban areas. Although the widths and depths of these trenches vary based on local municipality specifications, the most common dimensions of the trenches are at least 1" wide, and up to 12" deep.

One challenge faced when placing fiber into these trenches is making sure the fiber is laying at the bottom of the entire trench in order to avoid potential future damage by road re-surfacing or other maintenance activities on the surface above. We've created a quick and easy tool that will ensure that your fiber is tucked neatly at the bottom of the trench and out of harms way. The 3/4" thick, 14" long tamper fits easily into the slot-cut, and, with it's curved end design, fits snug to the fiber cable without pinching or cutting. The tamper end is made from 100% recycled plastics fitted over welded forged steel. The straight 48" hardwood handle makes it easy to use and quick to tuck away in the back of your truck.

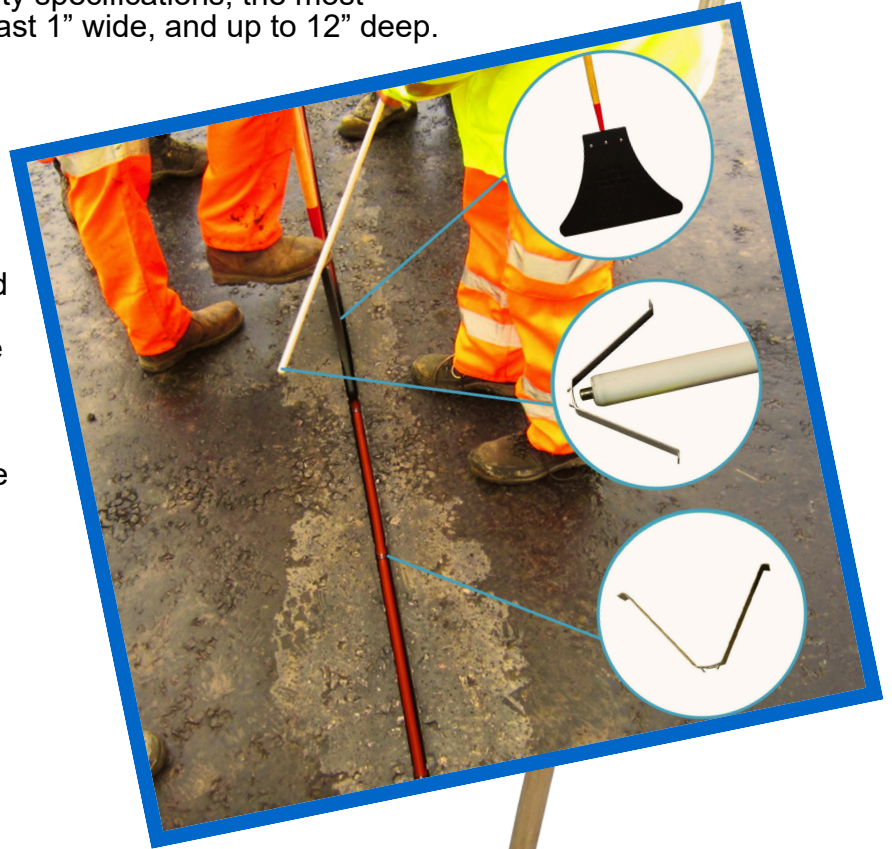

Features:

- 14" long, 3/4" wide tamping end
- Tamping end constructed from 100% recycled solid plastic
- Welded, forged steel handle attachment
- Designed for quick and easy use

Ordering Information

Product:	Description	VPN:
Micro-Trenching Tamper Tool	6.75 LBS	55400

www.uteck.com | 1-800-542-7011

TEMPORARY CABLE PROTECTORS

Rubber Cable Protector

- 5' long, Black, 11.4lbs
- Heavy Duty Single Channel Protector For Cable
- Reduces Tripping Hazards and Hose Lines Up To 1" Diameter
- Protects/Organizes Portable Cords & Cables
- Non-Metallic, Industrial-Grade Rubber Construction

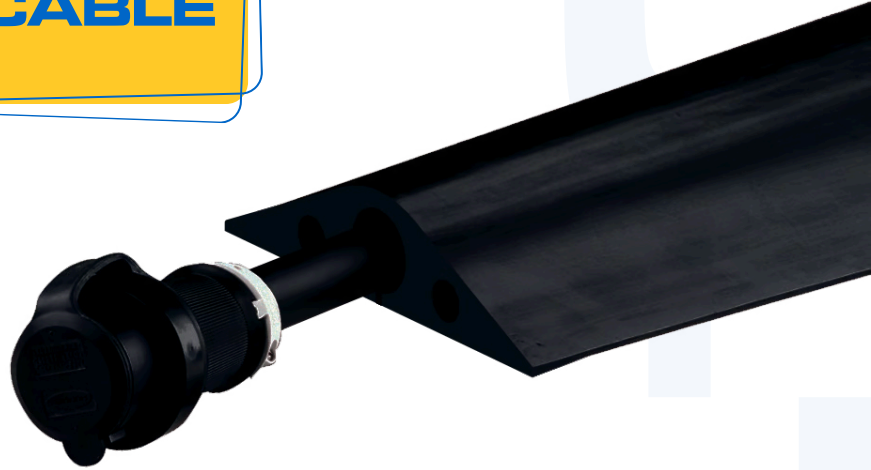

VPN: 55550

LID/BASE COLOR OPTIONS - Specify After Model Number



Yellow/Black=
Y/B

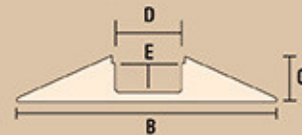

LOAD CAPACITY

Max load tested at 70°F (21°C)

7,990 lb./Tire (3,624 kg)
15,980 lb./Axle (7,248 kg)

A: LENGTH	36 in. (91.44 cm)
B: WIDTH	20.625 in. (52.39 cm)
C: HEIGHT	3.875 in. (9.84 cm)
D: CHANNEL WIDTH	2.875 in. (7.3 cm)
E: CHANNEL HEIGHT	2.875 in. (7.3 cm)
WEIGHT	42.6 lb. (19.3 kg)



Plastic Cable Protector

- Protects cables and hoses up to .75" outside dia.
- Dog-Bone Connectors to extend to any desired length
- Reinforced hinged lid for easy cable placement
- Patented 5-bar tread surface for maximum traction with standard ramps
- Modular interlocking design for easy setup
- 36" X 10.81", 1.25" H, 2.25" Channel Width, .75" Channel Height, 7.8 lbs

VPN: 55560

CABLE & WIRE STORAGE BOX

45

NEWLY REVISED!! U-TECK has come up with a practical solution to the problem of storing and transporting drop wire, station wire, and aerial drop wire shipping boxes.

Usually, these shipping boxes are out in the weather, getting wet, and disintegrating, making it more difficult to use them as they were intended. Also, theft of copper wire has become an ever increasing problem.

Features:

- Constructed from rustproof high density plastic
- Keeps contents dry in harsh conditions
- Measures 37" wide x 21" deep x 20" high
- Recessed soft grip handles
- Theft resistant key lock with 2 keys
- Fits all cable boxes you are using
- Three Cable Guides for easy payout
- Storage tray for loose tools or connectors
- Measurement guide on the top surface
- Made in the USA!



U-TECK has developed a Cable and Wire Storage Box that fits neatly in the back of service trucks and vans, keeping these boxes of wire and cable dry, safe and secure. Additionally, there are three cable guides on the front of the storage box so cable can be pulled from the inner boxes without having to unlock it. Each box is made from tough, high density, structural plastic, which will withstand the harshest elements. With a soft-feel, recessed handle on each end and a keyed lock for your cable, wire, and other contents are going to remain safe and ready when you need them.

Ordering Information

Product:

Description:

VPN:

Cable & Wire Storage Box

37" L x 21" W x 20" H

59101

www.uteck.com | 1-800-542-7011

RUNG RUNNER LADDER CADDY

U-TECK introduces the Rung Runner™, the easiest way to carry and transport heavy extension ladders from vehicle to job site. Using a universal tether, you can now carry any type of ladder, including large extension ladders with solid rails.

Features:

- Can be used with any style of ladder
- Reduces worker fatigue
- Helps prevent back strains and injury
- Decreases property damage
- Increases single-worker productivity
- Fast and easy assembly with most ladders
- Off-sets ladder weight for safer single-worker use



The Rung Runner™ has a unique design that enables it to cradle any type of extension ladders on their side, reducing the ladder weight by as much as 90%. This is the easiest and most stable way to carry them. Using the new Rung Runner™, worker fatigue is virtually eliminated, off-setting the weight of the ladder, making it lighter and more easily maneuverable into tight spots such as parking lots, construction sites, and into gated fences. Worker productivity is increased because of the ease of getting ladders to and from the work site more quickly. The framework is constructed of lightweight polymer and stainless steel, making U-TECK's Rung Runner™ extremely tough and durable.

Ordering Information

Product:

Rung Runner™ Ladder Caddy

Description:

12.5 LBS.

VPN:

59501-C

www.uteck.com | 1-800-542-7011

STEP RUNNER LADDER CADDY

47

U-TECK introduces the Step Runner™ Step Ladder Caddy , the easiest way to carry and transport heavy step ladders from vehicle to job site. Using a universal tether, you can now carry any type of step ladder.

Features:

- Can be used with any style step ladder
- Reduces worker fatigue
- Helps prevent back strains and injury
- Decreases property damage
- Increases single-worker productivity
- Fast and easy assembly
- Worry-free tires (easy to maintain)
- Off-sets ladder weight for safer single-worker use



The Step Runner™ has a unique design that enables it to cradle any type of step ladders on their side, reducing the ladder weight by as much as 90%. This is the easiest and most stable way to carry them. Using the new Step Runner™, worker fatigue is virtually eliminated, off-setting the weight of the ladder, making it lighter and more easily maneuverable into tight spots such as parking lots, construction sites, and into gated fences. Worker productivity is increased because of the ease of getting ladders to and from the work site more quickly, while being able to carry additional tools and equipment at the same time. The framework is constructed of lightweight polymer and stainless steel, making U-TECK's Step Runner™ extremely tough and durable.

Ordering Information

Product:	Description:	VPN:
Step Runner™ Ladder Caddy	17 LBS.	59501-STP

www.uteck.com | 1-800-542-7011

UNIVERSAL LADDER WEDGE

Years ago, U-TECK combined a longtime, craft-accepted wooden ladder wedge design with polyethylene material to produce a rugged ladder wedge that can be warranted for up to five years.

Using this material prevented paint scrapes and gouges by doing away with wood, and painting, all together; the color is molded throughout the polyethylene wedge. In reviewing this popular standard in ladder leveling, we found that the ladders most often used today by OSP personnel have transitioned to ladders with wider feet. Because of this research, we've increased the footprint size to each ladder wedge tier to accept up to 6-1/2" wide ladder feet. The "Universal" ladder wedge has all the same great features and load capacity as the original, but has now become much more versatile.

The Ladder Wedge is used when a ladder must be put against a building, cable, or pole, and one leg does not touch the ground firmly, thus creating an unsafe climbing condition. The Ladder Wedge is placed under the unlevel foot to make the ladder steady. The U-TECK Ladder Wedge is also needed on soft ground to prevent earth movement, which can cause the ladder foot to move while the user is climbing. The Ladder Wedge was put through rigorous testing by an outside testing facility. Their material analysis report concluded that no visible evidence of any deformation or failure of the wedge was noted at our specified 375 lb. minimum load or at their standard 396 lb. load test stop point.

Features:

- Supports ladders with feet up to 6.5" wide
- Prevent Accidents
- Available in Safety Yellow and High Visibility Orange
- Positive Footing
- Extremely Rugged
- Anti-Skid
- Adjustable
- Metal or Rubber Cleats



Ordering Information

Product:

Universal Yellow Ladder Wedge – Metal Cleats
 Universal Yellow Ladder Wedge – Rubber Cleats
 Universal Orange Ladder Wedge – Metal Cleats
 Universal Orange Ladder Wedge – Rubber Cleats

Description:

5 lbs., 16" X 9" X 6"
 5 lbs., 16" X 9" X 6"
 5 lbs., 16" X 9" X 6"
 5 lbs., 16" X 9" X 6"

VPN:

55429P-M
 55429P-R
 55429-POr-M
 55429-POr-R

POLE MOUNTED LADDER BRACKET

49

U-TECK's Pole Mounted Ladder Brackets provide a stable anchor while working at height.

Too often the angle of the ladder is positioned under the cabinets creating an unsafe angle for the worker to stand, open the cabinet, and perform routine functions

Features:

- Provides Correct Ladder Positioning for Techs
- Permanently attaches to poles under Cabinets
- Attachment point for Safety Harness
- Powder Coated Steel and Stainless Hardware
- Brackets are mounted to the pole using thru-bolts (not provided).
- Options:
 - Adjustable bracket sizes ranges from 21" to 27"
 - Fixed brackets offer 3 sizes 18", 21", and 24"

Used in conditions where Distribution Cabinets, UPS Cabinets and other equipment are mounted onto utility poles where technicians need ladder access.



*Pole Attachment Hardware Not Included

Ordering Information

Product:	Description:	VPN:
Pole Mounted Ladder Bracket -Almond	40Lbs	55900-001
Fixed Pole Mounted Ladder Bracket, fixed 18"	31Lbs	55905-18
Fixed Pole Mounted Ladder Bracket, fixed 21"	33Lbs	55905-21
Fixed Pole Mounted Ladder Bracket, fixed 24"	34Lbs	55905-24

www.uteck.com | 1-800-542-7011

LADDER BRACKET ASSEMBLY & INSTRUCTIONS



Position the Mounting Bracket at the desired location and mark the top mounting hole on the pole.



Drill through the pole making sure that there are no obstructions on the opposite side.



Loosely attach the Mounting Bracket using the appropriate pole mounting hardware.



Drill through the bottom mounting hole and insert the pole mounting hardware.



Securely tighten the Mounting Bracket to the pole.



Insert the Support Extension with the Safety Belt Bracket facing upwards.



Position the Support Extension to the desired location and line up the holes of the fiber cable to be used in both the Mounting Bracket and the Support Extension.



Insert (2) 4" hex head bolts with fender washers into adjusting holes on the side of the Mounting Bracket.



Attach additional fender washer, lock washer, and hex nut onto the bolts and fully tighten using a 5/8" socket and adjustable wrench.



Lean the ladder against the Pole Mounted Ladder Bracket and secure using your company's standard practice.



Secure yourself using your safety belt by looping your belt over and through the Safety Belt Bracket.

Pole Mounted Ladder Bracket (PMLB) Assembly
The PMLB consists of 2 parts, the Mounting Bracket and the Support Extension.

Support Extension

Pole Mounting Hardware
(not included)

Mounting Bracket

Safety Belt Bracket

Assembly Hardware located inside base section!

TEMPORARY FIBER DROP MARKERS

51

When new communication services are installed at a location, often a temporary cable is placed on the ground and left until such time as a crew can come and permanently bury the cable in the ground.

Features:

- Quick, easy, light weight
- 2.5" in diameter
- Highly visible fluorescent orange acrylic material
- Protects expensive cable drops prior to trenching
- Reusable

This leaves the cable vulnerable from damage caused by vehicle traffic, mowers and people tripping on the cable, not aware of its presence. U-TECK has developed a temporary solution to this problem. Our markers are made from a Highly Visible Fluorescent Orange Acrylic material that enhances the visibility of the cable and helps reduce damage that might occur.

Each marker is 2.5" in diameter. Simply insert the staple pin onto the marker disc with the message side up, straddle the cable with the marker, and push firmly into the ground. The arrow indicator should align with the direction of the cable. Space markers adequately for best results.

U-TECK's Temporary Fiber Drop Markers are meant to be reused. *Fully customizable with your Logo and company colors!*



Ordering Information

Product:	Description:	VPN:
Temporary Fiber Drop Marker	25/pack 100/box	55360

www.uteck.com | 1-800-542-7011

Handhole Cover Removal Tool

U-TECK's Handhole Cover Removal Tools allows users to safely remove handhole covers despite dirt and debris that may have accumulated or frozen.

Features:

- Made from lightweight polymer
- Easy to use
- Metal prongs to ensure easy use
- Ergonomically designed to allow the best grip for opening handhole covers
- Hole in center to allow for storage
- Simply place metal prongs into the handhole, and twist open to unlock
- Stainless Steel hardware



Ordering Information

Product:

Handhole Cover Removal Tool

Description:

10"

MAGIC WRAP

Magic Wrap® is an Emergency Repair Kit on a Roll.

A poly-butyl rubber compound, Magic Wrap® is activated when stretched. This activation causes Magic Wrap® to adhere to itself. Thus, any object which can be spiral wrapped can be repaired or sealed. Magic Wrap® is ideal for use on dirty or wet surfaces. Because there is no adhesive, there is no reason that dirt or moisture will cause it to fail. Repairs can even be done underwater!

Magic Wrap® is ideal for the following repairs:

- Automotive – will repair engine hoses, even fuel lines (to repair fuel lines, the white liner must be used first, then the Magic Wrap® over top of the white liner. The white liner prevents any reaction between the fuel and the Magic Wrap®.)
- Electrical – UL listed
- Plumbing – works on copper and PVC pipes under pressure – no need to turn off the source of water
- Sealing, weatherproofing, splicing, covering,
- holding/bundling, joining and repair applications General Household repairs
- Sporting goods – grips for hockey sticks, tennis rackets, fishing rods



Ordering Information

Description:

Magic Wrap 1" x 16' (48 rolls per box)
 Magic Wrap 2" x 16' (24 rolls per box)
 Magic Wrap 2" X 33' ROLL FLAME
 RETARDANT (1 ROLLS PER CASE)

Description:

7 lbs., 11.5" x 7.5" x 6"
 7 lbs., 11.5" x 7.5" x 6"
 12 lbs., 14" x 8" x 5"

VPN:

UT-80001
 UT-80031
 UT-82130

LIGHT INDUSTRIAL & UTILITY VENTILATOR

FEATURES:

- CFM rating of 877
- Lightweight, only 18 lbs. (8.2kg)
- Stackable
- Capability to connect up to 50 feet of straight duct
- Ideal for manhole applications
- UL & CUL listed



INDUSTRIAL HIGH CAPACITY VENTILATOR

FEATURES:

- CFM rating of 2796 (59.2 m3)
- Weighs on 32.5 pounds (14.74kg)
- Stackable to save storage or work area space
- Powerful 1Hp electric motor (.75 kW) capability
- Ideal for confined spaces that need greater airflow
- This model is available with an American 3-prong plug or with the European Shuko plug.



PNEUMATIC VENTILATOR

FEATURES:

- CFM rating of 2,063 (58.4 m3)
- Weights only 28 pounds (12.7 Kg)
- Stackable to save storage or work space area
- Powerful 1.5 Hp pneumatic motor
- Capability to connect up to 125 feet (38 m) of straight duct
- Redirect stale compressed air away from the main air stream
- UL and C-UL listed for use in Class I, Groups A, B, C and D; Class II, Groups E, F and G; and Class III Hazardous locations



HIGH CAPACITY VENTILATOR

FEATURES:

- CFM rating of 9,986
- Weighs 119 pounds
- Powerful 5Hp electric motor
- Two built-in handles
- Dual-wall shell design
- Ideal for larger areas that require greater airflow





DUCT WITH QUICK CONNECT - Available in 25 or 15 foot sizes for any model. Our duct hoses are made of flexible, light duty, vinyl, woven polyester. Ducts are easily retractable and designed to handle large volumes of air at relatively low pressure. The ducts are flame retardant and easily connect to fan lips for positive and/or negative airflow. Model 1225-SC duct is dipped in static conductive material for safe use in hazardous environments.

8" diameter by 15' length – VPN: U-0815

8" diameter by 25' length – VPN: U-0825

12" diameter by 25' length – VPN: U-1225

12" diameter by 15' length – VPN: U-1215



8-INCH DUCT COUPLER This circular metal ring will allow you to connect multiple sections of duct.

VPN: A-8000



DUCT CARRIER These lightweight polyethylene duct carriers hold up to 25 ft. each of 8-inch or 12-inch flexible ducting.

8 inch VPN: UTDSR-25-08P

12 inch VPN: UTDSR-25-12P



DUCT STORAGE RACK Our durable metal rack is perfect for safe duct storage. It can store up to two 15' duct lengths or one 25' duct. This rack is available for 8" or 12" wide ducts. 8" Duct Storage Rack

12" Duct Storage Rack

VPN: UTDSR-25-08

VPN:UTDSR-25-12

BUCKET LIFT HEATER

The Bucket Heater was designed with special features needed for use in elevated buckets.

Features:

- Solid Steel Construction
- Power 800w Reduced to 300w
- Inrush 13 Amps
Reduced to 3 Amps
- BTU: 5200
- Voltage: 110 - 120
- Size: 6" x 5" x 5"
- Weather Resistant



A front louver face panel protects the heating element from being damaged by wire cuttings, tools, etc., while protecting the user from coming into contact with heating surface. The cord and heavy duty metal cabinet remain cool during long periods of operation. The Bucket Heater promotes safety first with waterproof cord grommets and rubber covered switch handles, no dangerous flames, no combustible fuel or burning coils. The heaters have an optional electric shut off if tipped in any direction, making these the safest heating units available for any work area. Three prong electric plug and heavy duty cord meet OSHA standards for this type of heater.

Ordering Information

Product:	Description:	VPN:
Bucket Lift Heater	Heater only	38020

BIG BUDDY HEATER

This patented radiant 4,000-18,000 BTU Liquid Propane heater is the perfect solution for heating up to 450 sq. ft. An integrated fan increases the heating capacity of this unit, blending radiant and convection style heat to give you the best of both worlds.

Features:

- Ideal for use in the Vent Tent
- 4,000, 9,000, or 18,000 BTU per hour
- For use with propane gas
- Heats up to 450 sq. ft.
- Single control start knob
- Hi-Med-Low heat settings
- Swivel regulators
- Automatic low oxygen shut-off system (ODS)
- Accidental tip-over safety shut-off
- Connects to a 20 lb. cylinder with optional hose
- Fan operates on 4 D batteries



Two internal swivel regulators give you the ability to adapt usage from disposable cylinders to a remote gas supply with the purchase of a single hose and filter. (see below) To light the unit, simply push and rotate the knob. The built in Piezo sparking mechanism will take care of the rest. With the Oxygen Depletion Sensor (ODS) and accidental tip-over safety shut-off, you can be sure that you will enjoy years of comfortable outdoor safe heat.

Ordering Information

Product:	Description:	VPN:
Big Buddy Portable Heater Kit	Includes Heater, Hose and Filter	38000
Big Buddy Heater	Heater only, emits 4,000/9,000/18,000 BTU	38005
Propane Hose Assembly	12 FT. Hose	38010
Universal Fuel Filter	Filter only	38015

DIELECTRIC UMBRELLA

U-TECK's line of dielectrically safe fiberglass umbrellas provides a variety of options for protection from unknown electrical current as well as the elements.

Features:

- High-visibility, heavy duty, 7.5 ft wide, yellow umbrella with top air vents
- Fiberglass extension pole and skeleton for added safety

Includes:

- Adjustable tripod stand
- Three anchor stakes

Optional:

- Transparent 18-inch window to allow obstacles and hazards to be seen from below
- Carrying bags for additional storage
- Straight Pole
- Sturdy-Tilt Locking Hinge

Umbrella Carrying Bag



* Hinge higher to make the umbrella more sturdy and able to handle the weight of high winds or harsh weather

Adjustable Tripod Stand

Light enough to be used on mowers, tractors, etc.

Ordering Information

MODEL:

Non-tilt umbrella - clear window
 Non-tilt umbrella
 Tilt umbrella - clear window
 Tilt solid umbrella *
 Adjustable Tripod Stand
 7ft Carrying Bag

VPN:

73075CY
 73075Y
 73075CYT
 73075YT
 730TRI
 73007-B

U-TECK's line of umbrellas provides an economical method of protection from the elements.

Features:

- Heavy-duty construction
- Reinforced vinyl canopy
- 3-position tilt optional
- Aluminum/hardwood poles
- Pointed poles for easy set-up
- Strong enough to be used on mowers, tractors, etc.
- Lightweight
- Unique tilt-top feature allows user to shade themselves at any hour of the day.

• Optional Carrying Case:

- Carrying Case includes a separate pocket for the umbrella extension. Eliminating damage due to improper insertion of the umbrella.

• Additional accessories:

- Suction mount
- Adjustable tripod stand

Suction Mount

Heavy Duty Mount has 2 knobs to secure umbrella poles with suction-cup levers. *Cups are 4 1/2 in diameter.*
Lightweight yet strong ABS construction.



****For safety purposes, our umbrellas have a hardwood extension pole so no metal-to-metal contact can be made****

Ordering Information

PRODUCT:	Description:	VPN:
Work Umbrella, 5'6"	1 lb.	73005
Work Umbrella, 6'	1 lb.	73006
Work Umbrella, 7'	1 lb.	73007
Tilt Work Umbrella, 5' 6"	3 lbs.	73005-T
Tilt Work Umbrella, 6'	6 lbs.	73006-T
Suction Mount	16 lbs.	730MNT

www.uteck.com | 1-800-542-7011

BURIED CLOSURE PROTECTIVE HOUSING

The Safe Way to Protect Your Pressurized Closures from Ghost Leaks and your Filled Closures from Damage! Pressurized Closure: The buried closure protective housing (closure coffin) is designed to protect your pressurized closure from the weight of the back-fill, as well as from the added weight of vehicles that run over the splice location causing costly “Ghost Leaks”.

Features:

- Simple to install
- No special tools required
- Durable
- Convenient
- Few piece parts
- Re-enterable
- Chemical-resistant
- Cost-effective
- High-impact plastic
- Environmentally safe

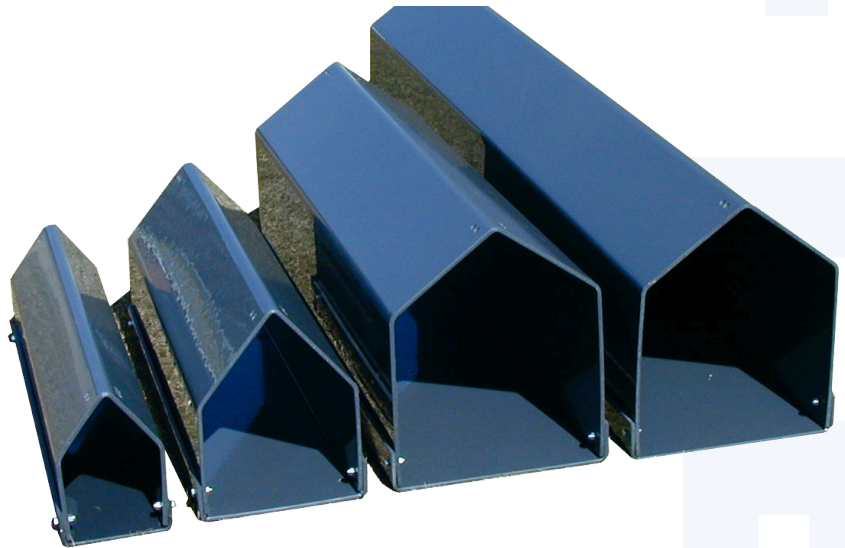

All pressure crews are very familiar with this problem: The weight of the dirt and road vibrations can cause the closure to become disfigured around the end plate, causing a small leak to occur. When the dirt is removed the closure recovers and the leak goes away. This is why it is called a ghost leak. Also, if cables are not secured and protected where they entered a drilled plate, a ghost leak might occur. The Buried Closure Protective Housing can eliminate this. Non-Pressurized: Even here, the closure can suffer damage from the weight of the dirt. We have come to realize that the re-enterable compounds do not provide the strength needed to withstand the weight. The Closure Coffin does. Also, in rocky areas, the sharp rocks can penetrate and deform many closures, allowing water to enter or causing damage from compression. Before the development of the Buried Closure Protective Housing, companies were using creosote- covered boards or other treated lumber, which decays, and sand or split pipe, which requires an excessive amount of labor. Now, with the Buried Closure Protective Housing, you have a uniform method to assure your company that the closure will be protected for the life of the cable.



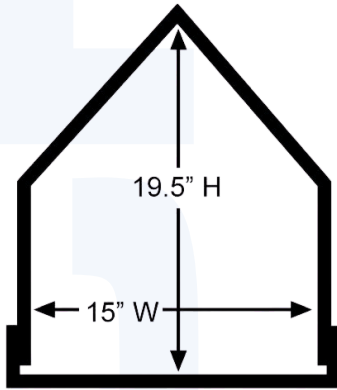

Product 57431 Series

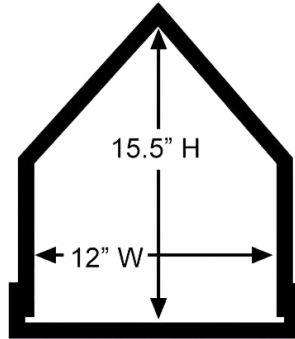

Product 55431 Series

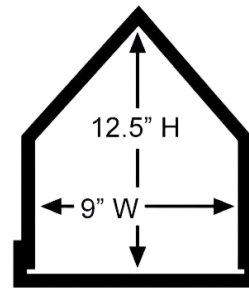

Product 53431 Series

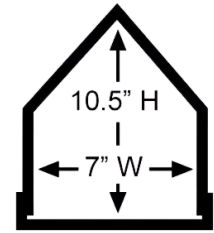

Product 51431 Series

ORDERING INFORMATION

Ordering Information							
Product Lengths	AB 38"	CD 51"	EF 59"	GH 68"	IJ 76"	KL 85"	
PRODUCT#	WT./LBS.	PRODUCT#	WT./LBS	PRODUCT#	WT./LBS	PRODUCT#	WT./LBS
57431 AB	49	55431 AB	40	53431 AB	34	51431 AB	28
57431 CD	66	55431 CD	54	53431 CD	45	51431 CD	37
57431 EF	76	55431 EF	62	53431 EF	52	51431 EF	43
57431 GH	88	55431 GH	72	53431 GH	60	51431 GH	50
57431 IJ	98	55431 IJ	80	53431 IJ	67	51431 IJ	55
57431 KL	110	55431 KL	89	53431 KL	75	51431 KL	62

TEST RESULTS

PROPERTY	UNIT	ASTM TEST NO.	RESULTS
Tensile Strength	PSI	D-838	7,000
Elongation at Yield	%	D-838	3.0
Modules of Elasticity in Tension	PSI	D-838	4.25 x 10 ⁴
Flexural Strength	PSI	D-790	10,000
Modules of Elasticity in Flexure	PSI	D-790	3.5 x 10 ⁴
Impact IZOD	FT/LBS	D-256	8 /. 1.5
Hardness Rockwell	"R"	D-785	118
Hardness Shore "D"	"D"	D-876	87
Compression Strength	PSI	D-895	10,000
Sheer Strength	PSI	D-732	7,550
Thermal Conductivity	BTU	/HR/FT ² /F/IN	1.16
Water Absorption		D-570	.12

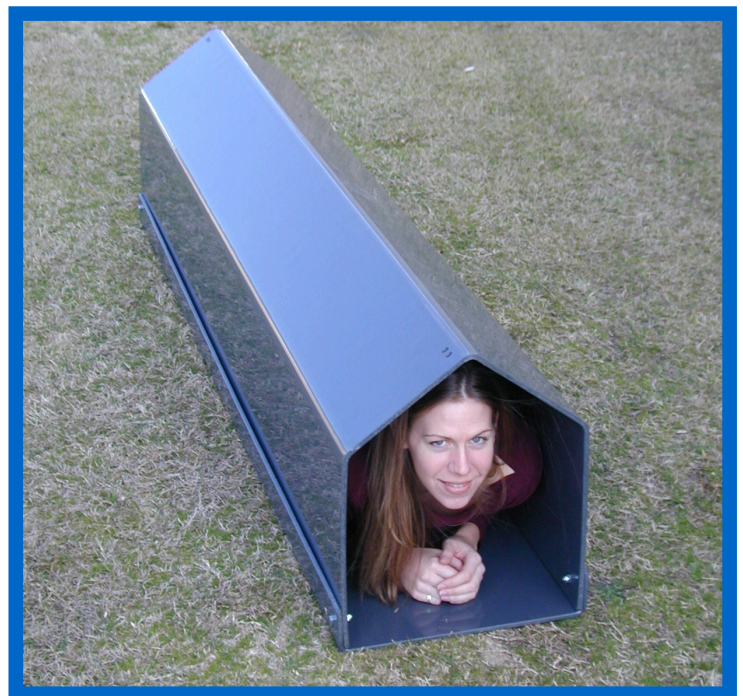

FEATURES:

- Designed for high inflows in precast or brick-lined structures
- Stops leaks of up to 50 GPM
- Can be injected into flowing water with a reaction time of 3 seconds
- Dual-component polyurethane grout
- Permanent fix
- 45 PSI compressive strength
- Each set of grout contains one cubic foot of cured material that will not shrink



A SealGuard II Kit contains:

- Twelve sets of dual-component polyurethane grout
- Twelve static mixers
- Dual-component heavy-duty caulk gun
- Safety goggles
- Two pairs of chemical gloves
- Safety clothing
- Instruction sheet
- MSDS sheet
- Convenient waterproof carrying case
- Top-notch support from SealGuard technicians

SealGuard II requires

only these tools:

- Hammer drill; 5/8" masonry bit; Hammer; Flat-tip screwdriver; Knife; Putty knife;
- Rags, oakum or burlap

From This



To This!



In JUST 30 SECONDS!

ATTIC-TRAX ILLUMINATED WALKBOARDS

Attic-Trax™ Illuminated Walk boards are used to assist techs intraversing safely through an attic space while performing functions such as wiring, inspections, equipment installations, pest control, etc.

Composed of a lightweight polymer, they are lightweight yet sturdy, and easy to maneuver. Each unit includes a convenient shoulder strap to enable 3 points of contact to be maintained while ascending and descending attics, stairwells and more.

Our proprietary Attic-Trax™ Illuminated have a rechargeable panel light attached to the underside, allowing the walk boards to be illuminated in dark spaces.

Features:

- 500 lb. load rating
- Adjustable Brightness
- Made from lightweight polymer
- Service temperature range: -40F to 180F
- Works in attics with 16" or 24" OC joist spacing
- Two 18" x 26" work surfaces per set
- High Visibility handles
- Non-Slip Surface
- Long Lasting Battery Life (see p.2)
- Traction studs at all 4 corners
- 3100mAh capacity battery
- Comes with TYPE C charging port
- Shoulder Strap included with all ATI purchases.

Low light conditions and power outages in the workplace increase health and safety hazards, and doing your **TM** utmost to eradicate the problems that may arise can save you and your employees a lot of hardship. The Attic-Trax Illuminated come with a chargeable battery affixed underneath, that provides light when turned on.

PICTURES SHOWN SHOT AT 50% BRIGHTNESS



Ordering Information

Product :	Description:	VPN:
ATTIC-TRAX ILLUMINATED WALKBOARD™ KIT (2) 18" X 26"	7LBS EA. 14LB SET	62028-L

www.uteck.com | 1-800-542-7011

ATTIC-TRAX ILLUMINATED

Great for Telecom, Electricians, HVAC, Pest Control, Plumbers, Contractors, Home Inspectors and MORE!

Warm and Cold Bi-color temperature and 10%- 100% brightness are adjustable. The lights can easily be removed with a single small thumb screw and recharged from the vehicle or office with the included charging cable. The lights can be brightened or dimmed. The diamond-plate surface provides a non-slip surface, while traction studs are installed at all 4 corners as an additional Anti-Slip measure.

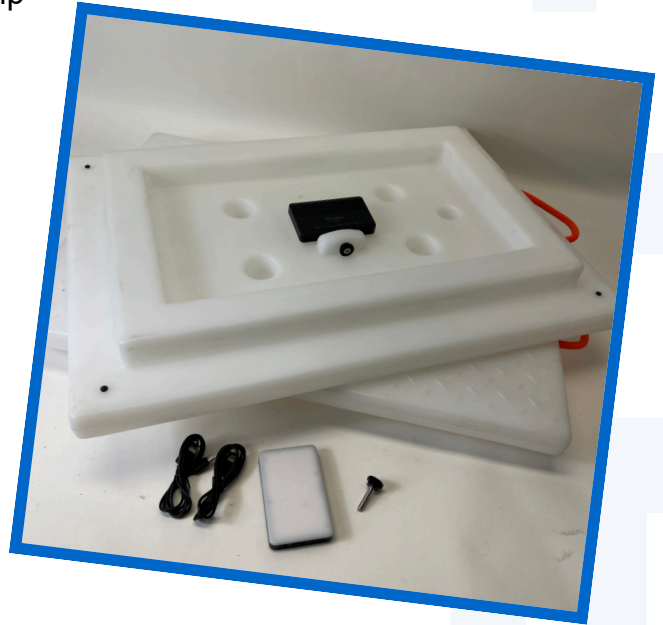

The intensity of the light can be adjusted. Brightness level does effect battery life as follows:

- ☀️ 100% BRIGHTNESS - 2.5 HR BATTERY LIFE
- 🌙 75% BRIGHTNESS - 3.5 HR BATTERY LIFE
- 🌓 50% BRIGHTNESS - 5 HR BATTERY LIFE
- 🌑 25% BRIGHTNESS - 6 HR BATTERY LIFE
- 🌑 10% BRIGHTNESS - 9.5 HR BATTERY LIFE

Charging time may vary between 1-2hrs

*Charger type will effect charging time

P A T E N T P E N D I N G

Ordering Information

Product :	Description:	VPN #:
Attic-Trax Illuminated™ Walkboard Kit (2) 18" X 2TM6"	7LBS EA. 14LB SET	62028-L

www.uteck.com | 1-800-542-7011

ATTIC-TRAX ILLUMINATED INSTRUCTIONS

65

TM

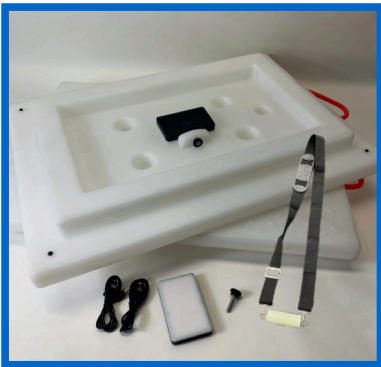

You will receive the parts shown with your Attic-Trax Illuminated Kit



The Light attaches and detaches from the bottom using the enclosed Thumb Screw



Power on using the switch on the side of the unit



Brightness and color temperature are also adjustable using the dials on the side



Close up of the dials on the side of the unit



Using HI-VIS handles for transport, position and stand on one unit.



Position the next board at a comfortable distance. Step onto that board. Pick up and reposition the board you just vacated. Repeat to traverse the attic.



Once at your desired location, you can utilize the walkboards for sitting, standing, wiring and more!



Power on to check battery life, which will be indicated on the side with the charging port. 4 lights is full charge, 2 is 50% etc... To charge, simply connect to the included charger into the USBC port

WHEEL CHOCKS

U-TECK's Hardwood Wheel Chocks are made from several pieces of maple wood joined together under high pressure with waterproof glue.

They are painted safety yellow with rugged, all-weather paint, sealing it from dirt, grime, and water. The galvanized hardware and handle offers long-life wear that is rust-resistant. Wheel Chocks with Steel tread offer rugged, no-skid durability with its galvanized, 4 diamond serrated surface

Features:

- Maple hardwood construction
- All galvanized metal handle, nuts, and bolts
- Galvanized 4 diamond, serrated surf, steel tread
- Steel loop carrying handle
- Fits most chock storage compartments
- Either side of wheel chock can be positioned against the tire

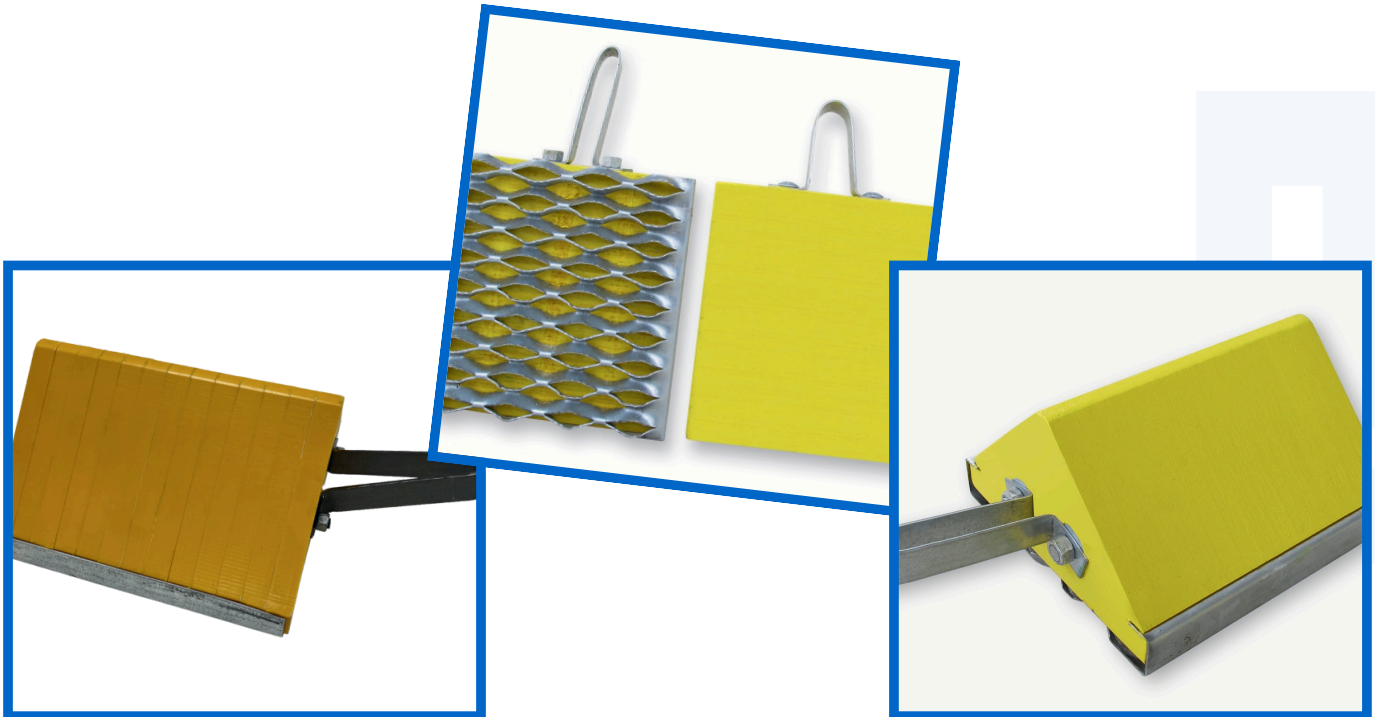

Plastic Wheel Chocks with Steel Tread

Hardwood Wheel Chocks with Steel Tread

Ordering Information

Product:	Description:	VPN:
Hardwood Wheel Chuck with metal handle	10" Length x 9.25" Width X 5.25 Height	63001
Hardwood Wheel Chuck with Steel Tread and metal handle	10" Length x 9.50" Width X 6" Height	63002
Plastic Wheel Chock with Steel Tread	10" Length x 9.50" Width X 6" Height	63002-YP

SAFE-T LID & VERSA LID

Designed with complete safety in mind, U-TECK's Safe-T Lid Temporary Covers provide fall-in protection while you perform various functions with a manhole or handhole lid removed.



Features:

- Available for use with Manholes or Handholes
- Made from high impact resistant polyethylene
- Environmentally stabilized to resist fading
- Lightweight and easily stored
- Custom sizes available
- Lightweight
- Strong
- Constructed from polyethylene
- Supports over 300 lbs. of direct weight



Featured on both the manhole and handhole temporary covers are openings along the edge large enough to accommodate cables that extend out of the hole, and two hand openings for easy transport, placement and removal. Often splicing crews working inside splicing trailers beside a manhole need to provide additional fall-in protection from the public as well as the crew members themselves. We offer various sizes of Safe-T Lid Temporary Covers to fit the following manhole sizes: 24", 28", 32", 36", and 38". The Safe-T Lid Temporary Covers for Handholes are available to fit the two most common handhole sizes: 24" x 36" and 30" x 48".

Ordering Information

Product:	Description:	VPN:
24" diameter manhole cover	9 LBS	28024-Y
28" diameter manhole cover	14 LBS	28028-Y
32" diameter manhole cover	19 LBS	28032 -Y
36" diameter manhole cover	22 LBS	28036C-Y
38" diameter manhole cover	25 LBS	28038C-Y
24" x 36" handhole cover	18 LBS	282436-Y
30" x 48" handhole cover	34 LBS	283048-Y

CHAIN HOIST

This hoist is economical and designed for years of trouble-free use, with pulling applications ranging from 3/4 ton to 3 ton capacity. The lift ranges available are: 5' and 10' lift lengths

Features:

- Simple design makes routine inspection and maintenance easy
- Steel construction with a rugged one-piece cast handle
- Freewheeling feature without load makes for quick load attachment
- Safety hooks swivel 360 degrees for easy rigging
- Induction hardened grade 80 load chain

This hoist is easy-to-use with its one-piece cast handle and includes a completely enclosed Weston type automatic brake system for precise load spotting. The chain is heat treated and hardened grade 80 load.

The simple design makes routine inspection and maintenance easy and a free wheeling feature without load makes for quick load attachment.

The permanently lubricated gears and drop forged, swivel 360 degree, safety hooks make for easier rigging. Complies with OSHA standards and is ISO 9001 certified.



Ordering Information

Product:

Chain Hoist 3/4 ton w/5ft lift and 11in lever
 Chain Hoist 3/4 ton w/10ft lift and 11in lever
 Chain Hoist 1 1/2 ton w/5ft lift and 17in lever
 Chain Hoist 1 1/2 ton w/10ft lift and 17in lever
 Chain Hoist 3 ton w/5ft lift and 17in lever
 Chain Hoist 3 ton w/10ft lift and 17in lever
 Chain Hoist 1/4 Ton Lever w/10' Lift

Description:

w/5ft lift and 11in lever
 w/10ft lift and 11in lever
 w/5ft lift and 17in lever
 w/10ft lift and 17in lever
 w/5ft lift and 17in lever
 w/10ft lift and 17in lever
 Lever w/10' Lift

VPN:

U187707
 U187708
 U187711
 U187712
 U187715
 U187716
 U181210

HANDI HOIST

U-TECK introduces the Handi-Hoist™, the easiest way to remove and replace heavy UPS batteries from aerial cabinets.

The Handi-Hoist™ was designed to assist field technicians in the routine task of removing and replacing heavy UPS batteries that are often located in aerial cabinets. Traditionally this job was performed by dangerously overloading the lifting capacity of bucket trucks or were simply carried up and down ladders. Most aerial lifts or bucket trucks have a lifting capacity of just 300 lbs. When you add an average worker and a set of tools, there's not much left for heavy items. Both methods are very unsafe and often the result could be personal injury or property damage.

Features:

- Attaches to any Wood, Composite, or Concrete Utility Poles
- Dual Safety Straps are quick and easy to lock down
- Non-Slip Rubber Pole Brackets are Universally Designed
- Payload Cannot Free Fall
- Rated lifting capacity of 175 lbs.
- Height lifting capacity of 30 feet
- Helps prevent personal injury
- Helps prevent property damage
- Folds for easy transport and storage
- Battery Sling and Cradle Included

U-TECK's Handi-Hoist™ is also very useful when installing Small Cell, or DAS Sites, installing Video Cameras, Traffic Cameras, Emergency Warning Sirens, Aerial Cabinets, etc. U-TECK designed a unique aerial hoist that is easily mounted onto a utility pole using 2, heavy duty, permanently attached, cinching straps. The rubber mounting brackets attached to the hoist frame have been designed using the profile specifications of many of the most commonly used utility poles. They are also capable of supporting the load in all kinds of weather conditions. When choosing the proper winch mechanism for the Handi-Hoist™, much consideration was taken to provide a reliable, fail-safe way to raise and lower a payload while keeping personnel and property on the ground safe. U-TECK selected a worm-drive winch for this product. This type of winch cannot accidentally go into "Free Spool" and cause injury or damage. The payload can only be raised and lowered using an ordinary cordless drill. When you want a payload raised, you first put the drill in forward, attach it to the 5/8" stud on the bottom of the winch and pull the trigger. When you want to lower the payload, put the drill in reverse and lower away. It's that easy!

Ordering Information

Product:	Description:	VPN:
Handi-Hoist	Handi-Hoist Lifting System 26.5" L x 13.75"Wx12.5"H	55810

HANDI HOIST EASY STEP-BY-STEP INSTALLATION

Handi-Hoist Features

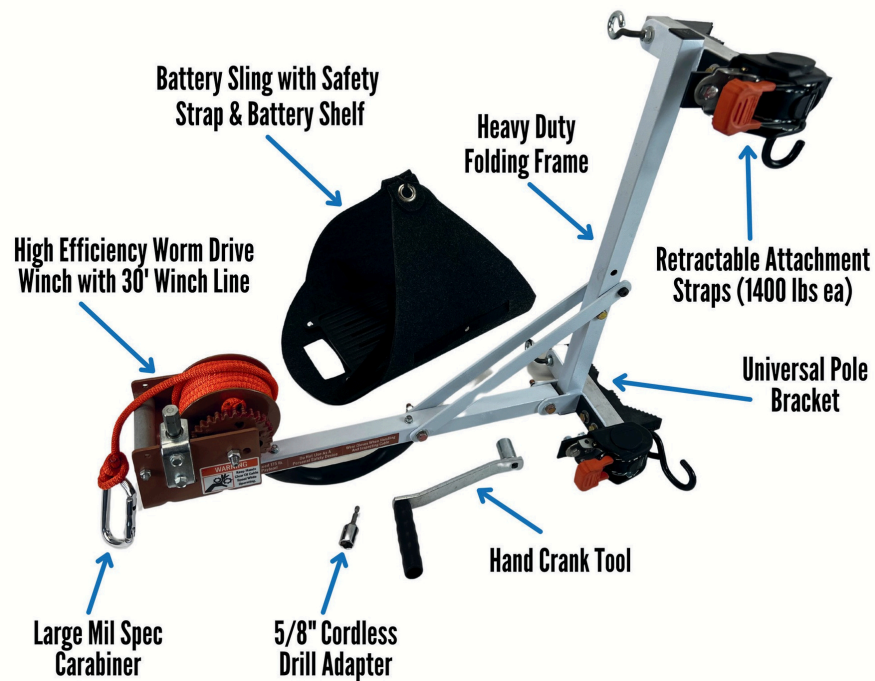

1 Position Handi-Hoist at the desired location on the pole and strap it securely using the 2 quick cinch safety straps.



2 Lower winch line to the ground using a cordless drill with 5/8" socked adapter (adapter included).



3 Attach Battery sling to the carabiner clip on the end of the winch line and place battery on the shelf to raise.



4 Using cordless drill in the forward direction, press the drill trigger to raise payload to the desired position.

NOTES

Let's connect!

Stay updated with our latest news and product information! Join us on social media for your daily dose of sustainable fiber optic solutions or visit our web by scanning the QR code.



www.UTECK.com



1-800-542-7011



Info@UTECK.com



U-TECK

U-TECKTM
YOUR SAFETY... OUR SOLUTIONS

159 Rock Hill Rd, Fayetteville NC 28312
+1 (800) 542-7011 | info@uteck.com